

WELCOME TO YOUR NEW FRANKE OVEN

You're about to begin a very happy and delicious relationship. Let's get started.

This is no ordinary oven.



FRE60M9B - 60CM 9 FUNCTION OVEN

MAKE IT WONDERFUL

FRANKE



AN IMPORTANT NOTE

Please read this document and the safety information carefully before you first use your oven.

SUPPORT

Speak to our customer service representatives.
Australia: 03 9700 9100 | info@prks.com.au
New Zealand: 09 964 0400 | info@prks.co.nz

WARRANTY

Your Franke product is protected by a 2-year warranty. Should you ever need to make a warranty enquiry, simply contact our service department.

Australia: 03 9700 9100 | service@prks.com.au
New Zealand: 09 964 0400 | service@prks.co.nz

GET SOCIAL

Keep up to date on all things Franke by following us on Facebook and Instagram.

@FrankeAUS
#makeitwonderful

"LET'S LET EVERYONE ELSE BE ORDINARY,
WHILE WE MAKE IT WONDERFUL"

CONTENTS

Chapter 1: Ready, set up, go

- 5 Introducing your new Franke oven
- 6 What's in the box?
- 6 First time use
- 6 Warnings and safety
- 6 Installation instructions
- 9 Setting the time
- 9 Child lock function
- 9 Environmental information
- 9 Disposal

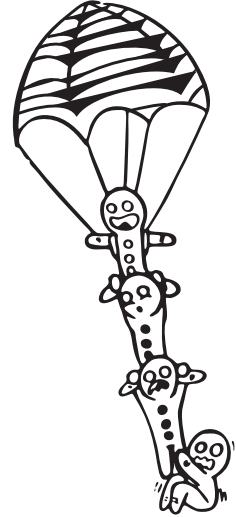

Chapter 2: Life with your Franke Oven

- 11 Functions
- 12 Operating your oven
- 12 Timer function
- 12 Pre-set cooking function
- 12 Auto shut-off timer

Chapter 3: Getting the most out of your Franke Oven

- 14 Cleaning and care
- 14 Interior lighting
- 14 Deactivating the LED display

Chapter 4: Problem, meet solution

- 16 Trouble shooting

Chapter 5: Last, but not least

- 18 Warnings, hazards, risks and legal

Looking for something?

- 19 Glossary

CHAPTER 1



READY, SET UP, GO

Your Franke oven is designed to be set up quickly and easily - so you can start creating delicious masterpieces even sooner.

INTRODUCING: YOUR NEW FRANKE OVEN



LEFT KNOB

Used to select the cooking function.

RIGHT KNOB

Used to select the cooking temperature and also to change the time.

START BUTTON

Used to start cooking, or confirm a ...

STOP / PAUSE BUTTON

Used to stop or pause cooking. Selecting this button twice turns the oven off.

PRE-SET COOKING TIMER BUTTON

Used to set the clock, and also for a pre-set cooking timer

REMINDER TIMER BUTTON

Used to set a cooking countdown timer.

ACCESSORIES

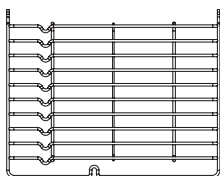

Slider bracket

Support the rails on the left and right of the oven.

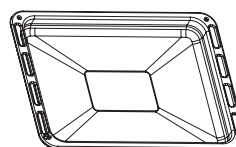

Universal pan

For cooking large quantities of food including cakes or frozen foods

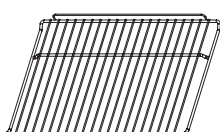

Wire shelf

For grilling, roasting or baking dishes.

WHAT'S IN THE BOX?

- 1 x Franke Oven
- 1 x Wire shelf
- 1 x Slider bracket
- 1 x Universal pan
- 1 x Power Cable

FIRST TIME USE

When the oven is first switched on, it may give off an unpleasant smell. This is due to the bonding agent used for the insulation panels within the oven.

Run the oven using the conventional cooking function, 250 degrees Celsius, for 90 minutes to clean all the impurities and to disregard the smell. Ensure that all packaging is removed.

Please note that the oven may emit a puff of white smoke upon first use.

WARNINGS & SAFETY

- The appliance will become hot during use and directly after use, care should be taken to avoid touching heating elements.
- This appliance is not intended for use by persons (including children) with reduced physical, sensory or mental capabilities, or lack of experience and knowledge, unless they have been given supervision or instruction concerning use of the appliance by a person responsible for their safety.
- Children should be supervised to ensure that they do not play with the appliance.
- CAUTION: Accessible parts may become hot when used with cooking appliances.
- If any parts become damaged, they must be replaced by the manufacturer only.
- Do not use abrasive cleaners or sharp metal scrapers during cleaning.

INSTALLATION INSTRUCTIONS

Check the appliance for damage after unpacking it, and don't connect the appliance if it has been damaged in transport.

Keep packing materials such as plastic bags and polystyrene out of reach of children as these are dangerous at all times.

Only a licensed professional may connect the appliance - damage caused by incorrect installation is not covered under the warranty. Ensure that the panels of the cabinetry around the oven are heat resistant, and the glues and materials can withstand temperatures of at least 120 degrees Celsius.

Ensure there is adequate air flow around the rear of the oven and there is a gap between the oven and kitchen unit.

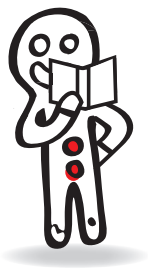

Shelf placement and warning

To ensure the oven shelves operate safely, correct placement of the shelves between the side rail is imperative. Shelves and the pan only can be used between the first and fifth layers.

Placement of the shelves should follow the installation instructions accurately and in the right direction to ensure no items will fall when removing the shelf or tray.

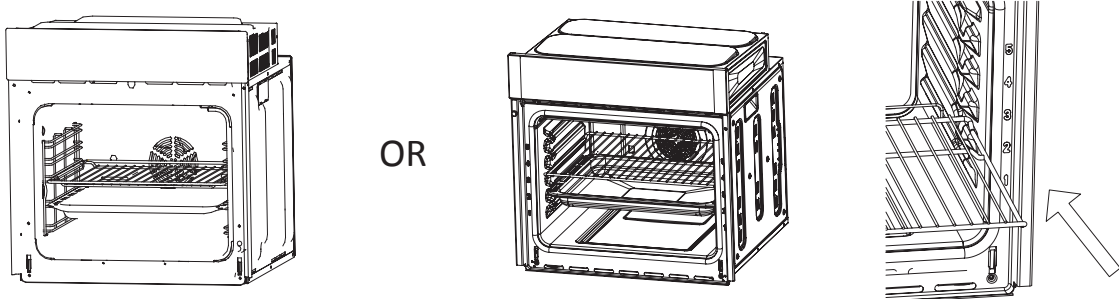

Bulb replacement

For replacement, process as follows:

1. Disconnect power from the mains outlet or switch off the circuit breaker of the unit's mains outlet.
2. Unscrew the glass lamp cover by turning it counter clockwise (note, it may be stiff) and replace the bulb with a new one of the same type.
3. Screw the glass lamp cover back in place.

NOTE: Only use 25-40W/220V-240V, T300°C halogen lamps.

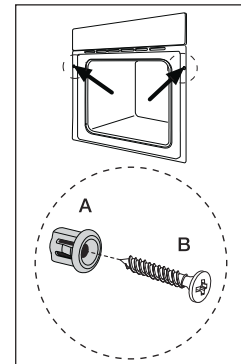
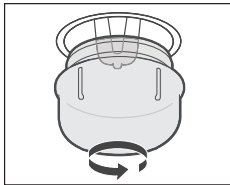

Securing the oven to the cabinet

1. Fit oven into the cabinet recess.
2. Open the oven door.
3. Secure the oven to the kitchen cabinet with two "A" distance holders which fit the holes in the oven frame and fit the two "B" screws.

Ventilating openings

When cooking is finished or in pause state or in waiting state, if the oven's center temperature is over 75 degree, the cooling fan will continue working for 15 minutes. Or when the oven's center temperature becomes lower than 75 degree, the cooling fan will stop in advance.

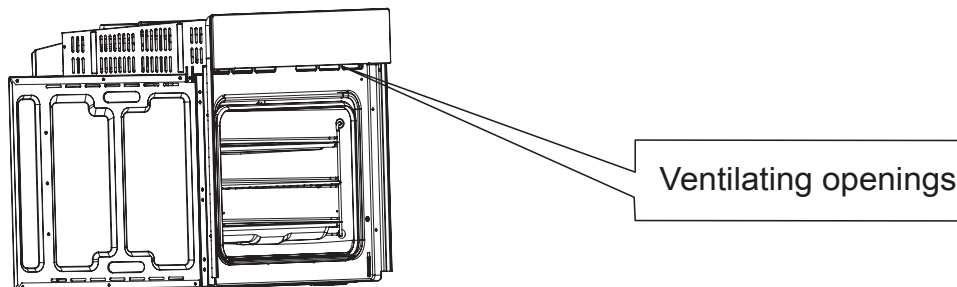

Connection of the oven wiring

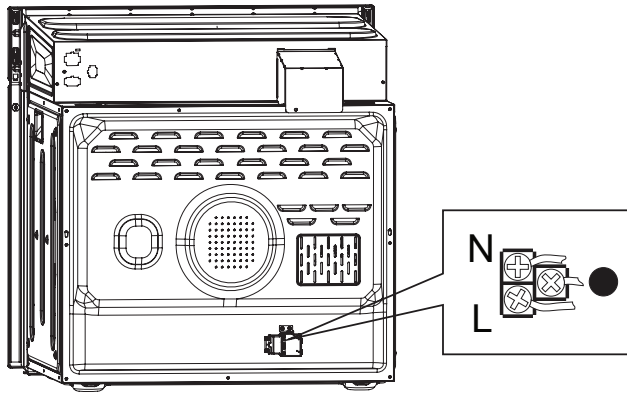

Cabinet Installation Dimensions

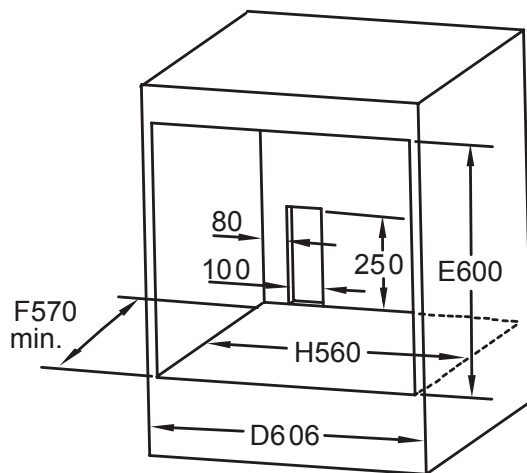
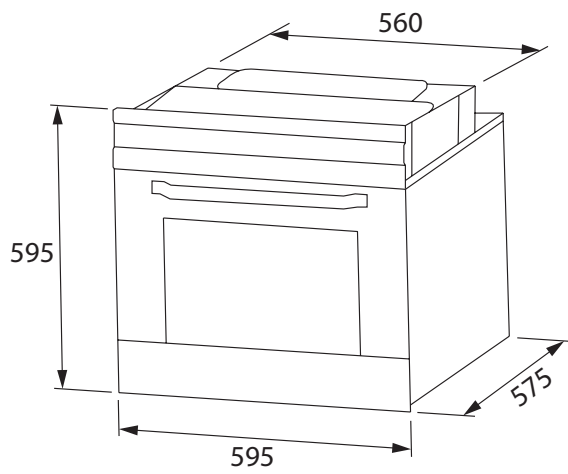

SETTING THE TIME

After connecting the unit to power, the symbols 0:00 will be shown on the display.

1. Press the **'Clock'** button until the hour figure flashes.
2. Rotate the **'Right knob'** to adjust the hour figure.
3. Press the **'Clock'** button so the minute figures flash.
4. Rotate the **'Right knob'** to adjust the minute figure.
5. Press the **'Clock'** button to confirm the new time settings.

CHILD LOCK FUNCTION

This oven comes fitted with a child lock feature for the protection of young children.

To activate hold: **'start'** and **'stop/pause'** simultaneously for 3 seconds. This will illuminate the **'lock'** icon.

To deactivate hold: **'start'** and **'stop/pause'** simultaneously for 3 seconds. This will release the child lock, and the **'lock'** icon will not be shown.

ENVIRONMENTAL INFORMATION

This Franke appliance is particularly energy efficient, however to make the most out of it, and to save even more energy make sure you adhere to the following steps:

1. Open the appliance door as infrequently as possible during operation.
2. It is best to bake several items on after the other, as the cooking compartment is still warm.
3. Only preheat the appliance if necessary for the recipe
4. For longer cooking times, you can switch the appliance off 10 minutes prior to the end cooking time, and use the residual heat.

DISPOSAL

Dispose of all packaging in an environmentally friendly manner. Franke practises environmentally conscious behaviour, and this appliance is labelled in accordance with the used electrical and electronic appliances waste guidelines.

If you have any questions on disposals, please call the Franke customer service team on 03 9700 9100.

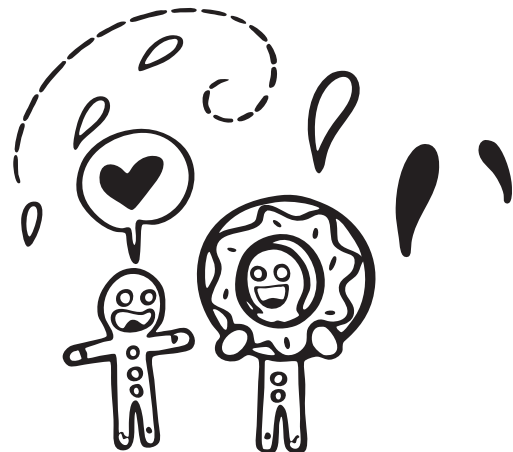

CHAPTER 2



LIFE WITH YOUR FRANKE OVEN

We designed this oven with one thing in mind.
How do we create a wonderfully simple user experience
for **you**, our customer?

OVEN FUNCTIONS



Oven Lamp

Which enables the user to observe the progress of cooking without opening the door. Oven lamp will light for all cooking functions.



Convection

A heating element plus fan force. This results in an even distribution of heat. Default temperature 180°C.



Defrost

Circulation of air at room temperature to speed up thawing of frozen food.

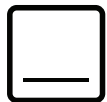

Bottom Heat

A concealed element in the bottom of the oven provides a concentrated heat to the base of food (ideal for pizzas). Default temperature 60°C.



Conventional Cooking

A top and bottom heating element work together to provide conventional cooking. Default temperature 220°C.



Double Grilling with Fan

The inside radiant heating element, and top element are working with the fan. Default temperature 210°C.



Radiant Grilling

The inner grill element maintains the temperature. Default temperature 210°C.



Double Grilling

The inside heating element and top element working together. Default temperature 210°C



Conventional with Fan

Combination of both the heating elements and the fan. This is also the most energy efficient setting. Lightly browned on the outside, moist on the inside (ideal for roasting).



OPERATING YOUR OVEN

To select a cooking function and choose your desired temperature:

1. Rotate the **'left knob'** to choose the cooking function.
The symbol chosen will be shown.
2. Rotate the **'right knob'** to adjust the temperature to your desired pre-set.
3. Press the **'start'** button to begin cooking.
4. Press the **'stop/pause'** button to stop/pause cooking function.
5. You can adjust the temperature at any stage. Rotate the **'right knob'** to desired temperature and press the **'on'** button again to update. If **'start'** is not pressed within 3 seconds, it will revert back to the previous temperature setting.
6. Press the **'stop/pause'** button for a second time to switch oven off.





REMINDER TIMER FUNCTION

The timer allows you to keep an eye over the amount of cooking time that has elapsed. With the cooking functions off, use the timer to set a reminder:



1. Press the **'timer'** button to select the hour figure.
2. Rotate the **'right knob'** to set the hour figure of the timer.
3. Press the **'timer'** button to select the minute figure.
4. Rotate the **'right knob'** to set the minute figure of the timer.
5. Press the **'start'** button to confirm. The time left until the buzzer sounds is now shown.

NOTE: Timer is not able to be used while cooking is in progress

PRE-SET COOKING FUNCTION

1. Press the **'pre-set timer'** button  once to select the required hour to commence cooking (the hour will flash until set).
2. Rotate the right control knob to the required hour (start time).
3. Press the **'pre-set timer'** button  again to adjust the minutes (if required).
This will flash until set.
4. Rotate the right control knob to the required minutes.
5. Select the desired cooking function with the left control knob.
6. Rotate the right control knob to adjust the temperature setting as required.
7. Press the **'start'** button .
8. Set the Auto Shut Off timer by rotating the left control knob to reach the desired cooking time required.
9. Press the **'start'** button , you will only see the  and the actual time of the day on, however not the selected function or temperature on the screen.
10. As the pre-set time arrives, the oven will switch on to the pre-selected function and temperature setting.
11. Once the Auto Shut Off timer counts back to zero, it will beep 3 times and completely switch off the oven.

AUTO SHUT-OFF TIMER

1. Select the required function (left knob).
2. Select the required temperature (right knob)
3. Press **'start'** button  to begin cooking.
4. Rotate the left control knob clockwise to select cooking time.
5. Then press the **'start'** button  to memorise. If start is not pressed within 3 seconds it will revert back to the previous time set.

CHAPTER 3



GETTING THE MOST OUT OF YOUR FRANKE OVEN

Getting the most out of your Franke oven.
Your Franke oven turns work into play, and inspires
creativity every single day.

CLEANING AND CARE

We want your Franke Appliance to be looking this good for a long time to come. To ensure that the various surfaces are not damaged through cleaning, please observe the following:

Glass: Glass cleaner and with a microfiber cloth.

Plastic: Hot soapy water with a soft cloth.

Control panel: Clean with a dish cloth and then dry with a soft cloth.

Interior enamelled surfaces: A mix of hot soapy water, vinegar and lemon juice. Wash with a dish cloth, and then allow the cooking compartment to dry.

Accessories: Hot soapy water and if there are stubborn food deposits, use a stainless steel scouring pad.

Rails: Hot soapy water and a dish cloth.

Stainless steel handle: Hot soapy water and a mild stainless steel cleaning product with a soft cloth.

INTERIOR LIGHTING

If the interior lighting bulb or cover is defective for any reason or the light no longer operates, please call our service team for support.

DEACTIVATING THE LED DISPLAY

If the illuminated control panel is too bright for your liking, it is possible to deactivate it temporarily while the oven is off.

Press and hold the **'start'** button for 3 seconds to deactivate the LED display. Pressing any button or turning the rotary knob will reactivate the LED display.

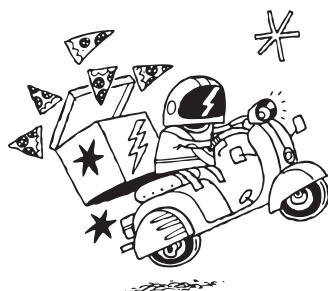

CHAPTER 4

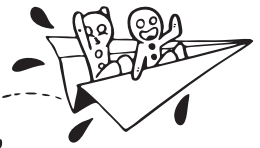

PROBLEM, MEET SOLUTION

We don't expect your experience with your new Franke oven to be anything but wonderful, but here's some trouble shooting remedies just in case.

TROUBLE SHOOTING

You shouldn't have any issues with your Franke Appliance, however there are some problems which can easily be fixed by trouble shooting the table below. If you can't find your problem, or the remedy has not fixed the issue, then give our friendly customer service team a call on 03 9700 9100, email info@prks.co.nz or info@prks.com.au

| Problem | Cause and Remedy |
|---|---|
| The appliance does not turn on | Check the circuit breaker or fuse box. Check to see if any other appliances are working. |
| The rotary knob can no longer be turned easily | There is dirt under the rotary selector. Press on the outer edge of the knob so that you can clean the opposite end. |
| Error message is displayed | Turn the oven on and off again. Cut power to the oven for 10 seconds. If the error remains please contact our support team and inform them of the error code. |
| Buttons not responding | Clean the control panel with hot soapy water, and ensure that hands are clean when operating buttons. |
| 0:00 is displayed on the control panel | Power has been cut since last use, and the clock has been reset. |
| Screen is blank | The oven either has had its power cut off, or is in energy saving mode. Press any button to exit power save mode. |

CHAPTER 5



LAST BUT NOT LEAST

This section contains the warnings, precautions and legal notices to make sure everything runs smoothly.

OVEN DOOR PRECAUTIONS

Never apply pressure on the oven door when it is closed or open. Never use the oven door as a seat or bench or apply any pressure to it while it is open. Do not place cookware or accessories on the oven door.

Glass that has become scratched poses a risk of cracking and ultimately shattering which is a serious risk to injury. Ensure that glass scraper or any sharp objects are kept away from the oven at all times.

The hinges on the oven door pose a threat for your hands to be trapped. Keep hands clear of the opening with operating the oven door.

ELECTRIC SHOCK HAZARD

Never carry out any repairs yourself, always get an authorized technician to do any repairs or maintenance on your oven. If any electrical components become damaged or there is exposed wiring, there is a risk of electrical shock.

Ensure whenever the oven is in operation and you come into contact with it, that appropriate footwear is worn.

HAZARDS

The following is a comprehensive list of all hazards and risks this product possesses.

Risk of fire:

- Any combustible items left in or near the oven during operation
- Be aware of baking paper coming into contact of the heating element.

Risk of burns:

- The appliance becomes very hot. Never touch any surfaces or compartments which have been exposed to the heating elements.
- Accessories also become very hot. Use appropriate gloves and ovenware.
- Alcoholic vapours may catch fire. Never use a high quantity of alcohol in a cooking recipe.

Risk of scalding:

- Any liquid in the cooking compartment may become hot and potentially dangerous if not handled carefully.

Risk of magnetism:

- Magnets are used during the creation and operation of the control panel. Keep away all pace makers.

Risk of electric shock:

- The insulation and coating of oven accessories may cause electric shock if they come into contact with electrical components.

Risk of death or serious injury to human health:

- The appliance will become extremely hot (around 250°C) during operation and any non approved cooking utensils may release noxious gases if left in the oven which are hazardous to human health.
- During the operation it is also extremely important to keep children away from the cooking compartment.
- The cables and wiring harnesses at the rear of the oven must not be tampered with or come into contact with the hot appliance.
- If the appliance is not operating correctly, do not continue to operate it. Discuss your problem with our customer service team.

GLOSSARY

Abrasive - a coarse and harsh substance capable of polishing or cleaning a surface by rubbing or grinding.

Buzzer - a device that makes a loud noise and is used to signal something.

Cabinetry - a collection of cupboards with drawers or shelves.

Circuit breaker - an automatic device for stopping the flow of current in an electrical circuit for safety reasons.

Control display - an electrical component which depicts various function on a screen, usually LED.

Convection - a fan with a heating element which provides heat. This improves the heat transfer.

Conventional - the heat source is stationary, usually radiating from the bottom or top.

Enamelled - a coat of paint which is extremely heat resistant. It is applied by fusion to the metal.

Food residue - a small amount of food which remains after cooking.

Heating element - converts electricity into heat through resistive current.

Insulation - protecting or shielding an object from excessive heat or moisture.

Licensed professional - a person who has had the proper training and prerequisite to complete a certain job.

Manufacturer - the person or organisation which is the original producer of a product.

Metal scraper - a single edged tool used to scrape a surface clean.

Packaging - the materials used to wrap or protect goods.

Radiant grilling - dry heat applied from above or below from a heating element.

Rotary knob - a wheel which control certain function and can spin left or right.

Scalding - very hot burning and blistering

Timer - used to indicate how long a process has left remaining.

Trouble shooting - finding the causes of common problems.

User experience - the overall experience of a person using a product, in terms of how easy or pleasing it is to use.

Warranty - a written guarantee promising to repair or replace a product under certain circumstances within a certain time.

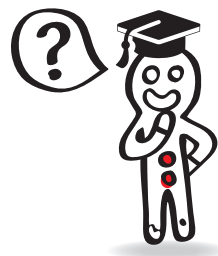

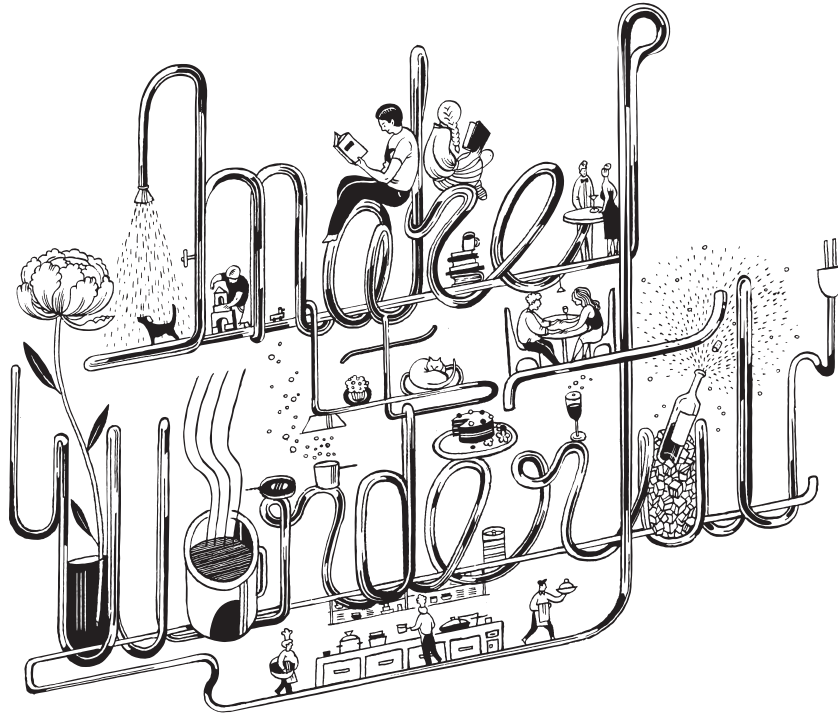

PR Kitchen & Washroom Systems
 83 Bangholme Road
 Dandenong South
 VIC 3175
 Australia
 Phone +61 3 9700 9100
 Fax +61 3 9700 9191
info@prks.com.au
www.franke.com.au

PR Kitchen & Washroom Systems NZ Ltd
 P.O. Box 53171, Auckland Airport
 Auckland 2150
 New Zealand
 Phone 09 964 0400
 Fax 09 964 0401
info@prks.co.nz
www.franke.co.nz

