

# Dishwasher

## Instruction Manual

FCDW60FI



Please read this manual carefully  
before using the dishwasher and  
Keep this manual for future reference.

# Franke – Urban Appliances Express Warranty

## Australian Consumer Guarantees

Our goods come with guarantees that cannot be excluded under the Australian Consumer Law. You are entitled to a replacement or refund for a major failure and compensation for any other reasonably foreseeable loss or damage. You are also entitled to have the goods repaired or replaced if the goods fail to be of acceptable quality and the failure does not amount to a major failure.

## Express Warranty Details

As well as your consumer guarantees under the Australian Consumer Law, PR Kitchen and Washroom Systems Pty Ltd ACN 138 663 279 (**PRKS**) offers original purchasers of the Products (**Customer** or **you**) the additional express warranty described in this document (**Express Warranty**) in respect of Urban appliances used in a domestic/residential setting (**Product**).

The benefits provided under this Express Warranty are additional to other rights and remedies available to the Customer under the Australian Consumer Law and do not derogate or reduce your rights under the Australian Consumer Law.

The conditions, limitations and exclusions that apply to this Express Warranty are set out in this document.

This Express Warranty is not transferable and is given to Customers when the Product is used in a domestic or residential setting.

## Term of the Express Warranty

The Express Warranty is valid for 2 Years from date of purchase of the Product (**Warranty Period**).

## Express Warranty

Subject to the terms set out in this document, PRKS warrants to Customers that the Product will be free from defects in materials and workmanship during the Warranty Period.

If the Product fails to operate or is defective during the Warranty Period under normal operating conditions as a result of a defect in materials or workmanship, subject to the exceptions set out under the heading **Conditions** below, PRKS will, at its discretion either:

- replace the Product or a component of the Product; or
- repair the Product or a component of the Product using new, used or refurbished replacement parts,

## Conditions

This Express Warranty does not cover and expressly excludes: damage to the Product or a defect in or failure of the Product resulting directly or indirectly from any of the following:

- alteration, modification or disassembly of the Product;
- the Product being used in a way for which it was not designed or in a manner contrary to the instructions provided with the Product (including in respect of maintenance of the Product);
- abuse, misuse, negligence, willful damage neglect or vandalism;
- corrosion from environmental conditions or chemical treatments;
- fire, accident or theft;
- damage caused while the Product is being
- external sources, including but not limited to blown fuses, power failure, faulty installation;
- natural disasters, or other 'acts of God', including but not limited to damage from flooding, drought, lightning, hurricanes, hail, windstorms, earthquakes, tornadoes, gales, cyclones or other causes beyond the control of PRKS; or
- normal wear and tear;
- scratching, denting, rusting, spotting, discolouration or tampering with the Product. Any imperfections in the finishes or in the natural materials used should not be considered as faults but a typical characteristic of these crafted products;
- Products:
  - used in commercial settings;

- that were not installed in accordance with the manufacturer's installation instructions, by a qualified installer and licensed plumber or in accordance with any applicable standards published by Standards Australia that apply to the Product; or
- that were purchased second hand, at auction, or from a person other than an authorised representative of PRKS;
- maintenance or repair performed by unauthorised persons and/or use of spare parts that are not genuine;
- when the Customer cannot provide documentation evidencing date of purchase of the Product;
- incidental, indirect or consequential loss or damage including loss of or damage to property, injury to, illness or death of, any person in connection with a Product failure or defect; or
- product removal or re-installation costs, visits and calls of specialised technicians and costs borne by the Customer due to the unavailability and/or non-use of the Product.

The Remedy is the sole remedy under this Express Warranty.

### **Extra Representations**

No representation or warranty by any person, including a PRKS employee or agent, shall be binding to the extent that they are inconsistent with or to the extent that the representation expands this Express Warranty unless expressly incorporated in writing in this document. This Express Warranty supersedes and overrides all prior agreements, representations and warranties made by PRKS and its authorised agents.

### **Making an Express Warranty Claim**

If the Customer becomes aware, or ought reasonably be aware of any defect, damage or deterioration to the Product, the Customer must stop using the Product and promptly report it to PRKS within the Warranty Period

To make a claim under this Express Warranty, please contact PRKS by submitting an enquiry at [www.prkws.com](http://www.prkws.com) or you can call (03) 9700 9100 to speak with our friendly customer care consultants.

You will need to provide us with:

1. model number of your Product
2. product identification (e.g., serial number);
3. details of the problem you have experienced with the Product;
4. a copy of your original purchase receipt;
5. address details of where the product is installed; and
6. any relevant pictures can be attached if lodging the claim online.

Express Warranty claims received after the Warranty Period will not be accepted.

### **Expenses**

Subject to the following terms, PRKS will provide the Remedy to the Customer at its cost:

- PRKS is not responsible for any associated or ancillary costs that you incur as a result of replacement or repair of your Product unless PRKS has given its prior written approval.
- Where a claim has been made under this Express Warranty and the Product is located outside of a 50km radius from any store where the Product can be purchased from an authorised retail (**Warranty Area**), you are responsible for the cost of delivery to the nearest service agent or the travel cost for a technician to travel to a location outside the Warranty Area.

### **PR Kitchen & Washroom Systems Pty Ltd**

83 Bangholme Road

Dandenong South, VIC 3175, Australia

Phone: 03 9700 9100

Email: [customercare@prks.com.au](mailto:customercare@prks.com.au)

Website: [www.prkws.com](http://www.prkws.com)

# CONTENTS

01	<b>4</b>	<b>USING YOUR DISHWASHER</b>
	<b>4</b>	Control Panel
	<b>6</b>	Preparing And Loading Dishes
	<b>9</b>	Function Of The Rinse Aid And Detergent
	<b>10</b>	Filling The Rinse Aid Reservoir
	<b>11</b>	Filling The Detergent Dispenser
02	<b>12</b>	<b>PROGRAMMING THE DISHWASHER</b>
	<b>12</b>	Wash Cycle Table
	<b>13</b>	Starting A Cycle Wash
	<b>13</b>	Changing The Program Mid-cycle
	<b>14</b>	Forget To Add A Dish?
03	<b>15</b>	<b>ERROR CODES</b>
04	<b>16</b>	<b>TECHNICAL INFORMATION</b>

## **NOTE:**

- If you cannot solve the problems by yourself, please ask for help from a professional technician.
- The manufacturer, following a policy of constant development and updating of the product, may make modifications without giving prior notice.
- If lost or out-of-date, you can receive a new user manual from the manufacturer or responsible vendor.

# QUICK USER GUIDE

Please read the corresponding content on the instruction manual for detailed operating method.

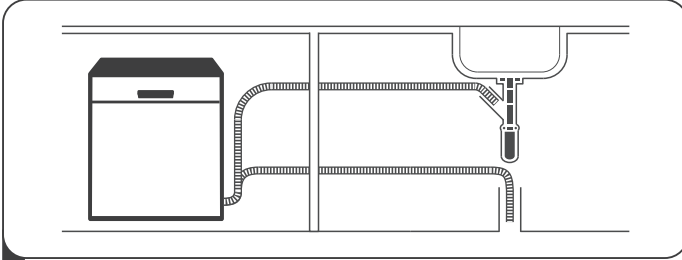

- 1 Install the dishwasher  
**(Please check the section 5 "INSTALLATION INSTRUCTION" of PART I: Generic Version.)**



- 2 Removing the larger residue on the cutlery

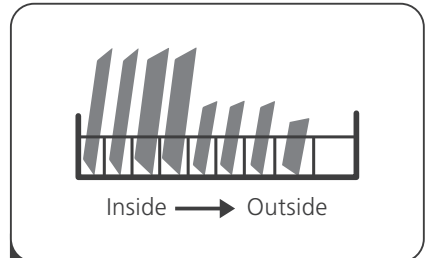

- 3 Loading the baskets

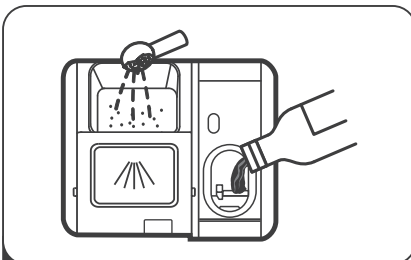

- 4 Filling the dispenser







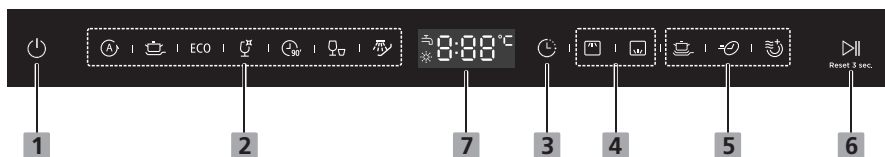

- 5 Selecting a program and running the dishwasher









# USING YOUR DISHWASHER

## Control Panel



### Operation (Button)

<b>1 Power</b>	Press this button to turn on your dishwasher, the screen lights up.
<b>2 Program</b>	<p> <b>Auto</b> Auto sensing wash, lightly, or heavily soiled crockery, with or without dried-on food</p> <p> <b>Intensive</b> For heaviest soiled crockery, such as pots, pans, casserole dishes and dishes that have been sitting with dried food on them for a while.</p> <p><b>ECO</b> <b>ECO</b> For normally soiled loads, such as pots, plates, glasses and lightly soiled pans, standard daily cycle.</p> <p> <b>Glass</b> For lightly soiled crockery and glass.</p> <p> <b>90 min</b> For lightly soiled plates and pans that need quick wash.</p> <p> <b>Rapid</b> A shorter wash for lightly soiled loads that do not need drying.</p> <p> <b>Soak</b> To rinse dishes that you plan to wash later that day.</p>

<b>3 Delay</b>	Press this button to set the delayed hours for washing. You can delay the start of washing up to 24 hours. One press on this button delays the start of washing by one hour.
<b>4 Alt</b>	Press the buttons to select either upper basket or lower basket loaded, and the response indicators will be lit.
<b>5 Function</b>	<p>  <b>Power Wash</b>          To wash very dirty, hard to clean dishes.          (It can only be used with Intensive, ECO, Glass, 90 min)       </p> <p>  <b>Express</b>          Reduce the program time.          (It can only be used with Intensive, ECO, Glass, 90 min)       </p> <p>  <b>Extra Drying</b>          To dry dishes more completely.          (It can only be used with Intensive, ECO, Glass, 90 min)       </p>
<b>6 Start/Pause</b>	Press the button to start the selected program, or press the button for 3 seconds to cancel the selected program.
<b>7 Screen</b>	<p>  <b>Water Faucet</b>          If the “” indicator is lit, it means the water faucet closed.       </p> <p>  <b>Rinse Aid</b>          If the “” indicator is lit, it means the dishwasher is low on dishwasher rinse aid and requires a refill.       </p> <p>          Show the program lasting time, error code and main wash etc.       </p>

# • Preparing And Loading Dishes

---

- Consider buying utensils which are identified as dishwasher-proof.
- For particular items, select a program with the lowest possible temperature.
- To prevent damage, do not take glass and cutlery out of the dishwasher immediately after the program has ended.

## For washing the following cutlery/dishes

### Are not suitable

- Cutlery with wooden, horn china or mother-of-pearl handles
- Plastic items that are not heat resistant
- Older cutlery with glued parts that are not temperature resistant
- Bonded cutlery items or dishes
- Pewter or cooper items
- Crystal glass
- Steel items subject to rusting
- Wooden platters
- Items made from synthetic fibres

### Are of limited suitability

- Some types of glasses can become dull after a large number of washes
- Silver and aluminum parts have a tendency to discolor during washing
- Glazed patterns may fade if machine washed frequently

## Recommendations for loading the dishwasher

Scrape off any large amounts of leftover food. Soften remnants of burnt food in pans. It is not necessary to rinse the dishes under running water.

For best performance of the dishwasher, follow these loading guidelines.

**(Features and appearance of baskets and cutlery baskets may vary from your model.)**

Place objects in the dishwasher in following way:

- Items such as cups, glasses, pots/pans, etc. are faced downwards.
- Curved items, or ones with recesses, should be loaded aslant so that water can run off.
- All utensils are stacked securely and can not tip over.
- All utensils are placed in the way that the spray arms can rotate freely during washing.



## Recommendations for loading the dishwasher

Scrape off any large amounts of leftover food. Soften remnants of burnt food in pans. It is not necessary to rinse the dishes under running water.

For best performance of the dishwasher, follow these loading guidelines.

**(Features and appearance of baskets and cutlery baskets may vary from your model.)**

Place objects in the dishwasher in following way:

- Items such as cups, glasses, pots/pans, etc. are faced downwards.
- Curved items, or ones with recesses, should be loaded aslant so that water can run off.
- All utensils are stacked securely and can not tip over.
- All utensils are placed in the way that the spray arms can rotate freely during washing.
- Load hollow items such as cups, glasses, pans etc. With the opening facing downwards so that water cannot collect in the container or a deep base.
- Dishes and items of cutlery must not lie inside one another, or cover each other.
- To avoid damage, glasses should not touch one another.
- The upper basket is designed to hold more delicate and lighter dishware such as glasses, coffee and tea cups.
- Long bladed knives stored in an upright position are a potential hazard!
- Long and/or sharp items of cutlery such as carving knives must be positioned horizontally in the upper basket.
- Please do not overload your dishwasher. This is important for good results and for reasonable consumption of energy.

### **NOTE:**

Very small items should not be washed in the dishwasher as they could easily fall out of the basket.

## Removing the dishes

To prevent water dripping from the upper basket into the lower basket, we recommend that you empty the lower basket first, followed by the upper basket.

### **WARNING**



**Items will be hot!** To prevent damage, do not take glass and cutlery out of the dishwasher for around 15 minutes after the program has ended.

## Loading the upper basket

The upper basket is designed to hold more delicate and lighter dishware such as glasses, coffee and tea cups and saucers, as well as plates, small bowls and shallow pans (as long as they are not too dirty). Position the dishes and cookware so that they will not get moved by the spray of water.



## Loading the lower basket

We suggest that you place large items and the most difficult to clean items are to be placed into the lower basket: such as pots, pans, lids, serving dishes and bowls, as shown in the figure below. It is preferable to place serving dishes and lids on the side of the racks in order to avoid blocking the rotation of the top spray arm.

The maximum diameter advised for plates in front of the detergent dispenser is of 19 cm, this not to hamper the opening of it.

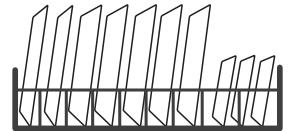

## Loading the cutlery basket

Cutlery should be placed in the cutlery rack separately from each other in the appropriate positions, and do make sure the utensils do not nest together, this may cause bad performance.

### **⚠ WARNING**



Do not let any item extend through the bottom.  
Always load sharp utensils with the sharp point down!



For the best washing effect, please load the baskets refer to standard loading options on last section of PART I: Generic Version

# Function Of The Rinse Aid And Detergent

The rinse aid is released during the final rinse to prevent water from forming droplets on your dishes, which can leave spots and streaks. It also improves drying by allowing water to roll off the dishes. Your dishwasher is designed to use liquid rinse aids.

## ⚠ WARNING

Only use branded rinse aid for dishwasher. Never fill the rinse aid dispenser with any other substances (e.g. Dishwasher cleaning agent, liquid detergent). This would damage the appliance.

## When to refill the rinse aid dispenser

The regularity of the dispenser needing to be refilled depends on how often dishes are washed and the rinse aid setting used.

- The Low Rinse Aid indicator (  ) will appear in the display when more rinse aid is needed.
- Do not overfill the rinse aid dispenser.

## Function of detergent

The chemical ingredients that compose the detergent are necessary to remove, crush and dispense all dirt out of the dishwasher. Most of the commercial quality detergents are suitable for this purpose.

## ⚠ WARNING

- Proper Use of Detergent

Use only detergent specifically made for dishwashers use. Keep your detergent fresh and dry.

Don't put powdered detergent into the dispenser until you are ready to wash dishes.



**Dishwasher detergent is corrosive! Keep dishwasher detergent out of the reach of children.**

## Filling The Rinse Aid Reservoir

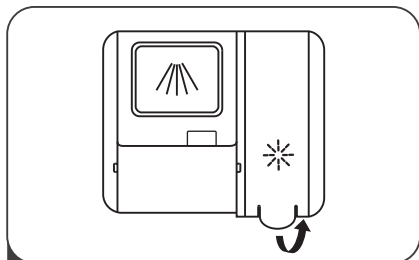

- 1 Remove the rinse reservoir cap by lifting up the handle .

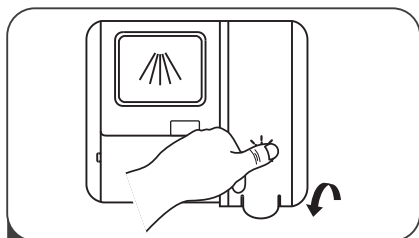

- 3 Close the cap after all.

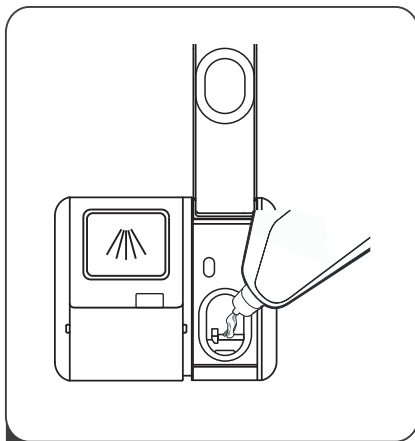

- 2 Pour the rinse aid into the dispenser, being careful not to overfill.

### Adjusting the rinse aid reservoir

To achieve a better drying performance with limited rinse aid, the dishwasher is designed to adjust the consumption by user. Follow the below steps.

1. Open the door and switch on the appliance.
2. Within 60 seconds after step 1, press the Program button more than 5 seconds, the rinse aid indication blinks as 1Hz frequency.
3. Press the Program button to select the proper set according to your using habits , the sets will change in the following sequence: D1->D2->D3->D4->D5->D1. The higher the number, the more rinse aid the dishwasher uses.
4. Without operation in 5 seconds or press the Power button to exit the set model, the set success.

# Filling The Detergent Dispenser

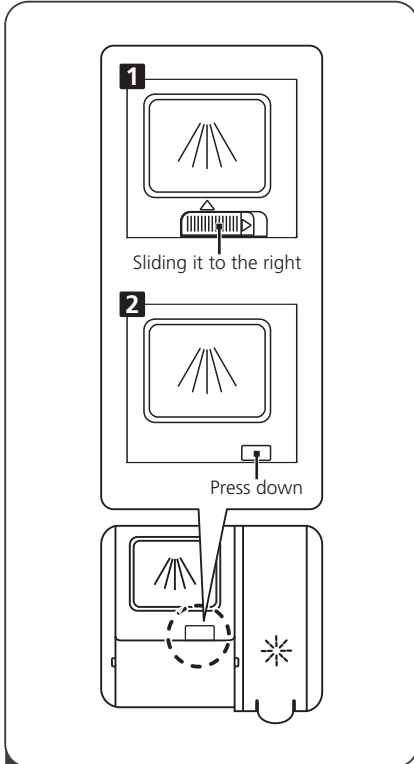

**1** Please choose an open way according to the actual situation.

1. Open the cap by sliding the release catch.
2. Open the cap by pressing down the release catch.

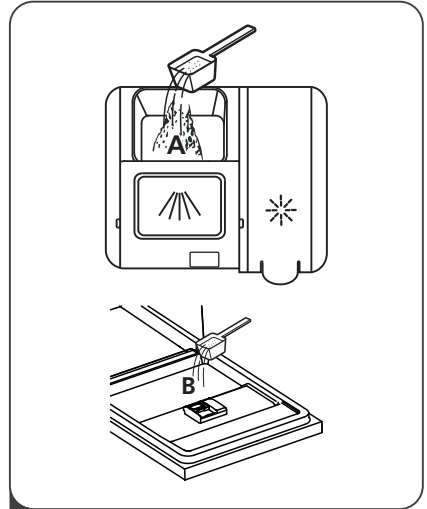

- 2** Add detergent into the larger cavity (A) for the main wash cycle . For better cleaning result, especially if you have very dirt items, pour a small amount of detergent onto the door. The additional detergent will activate during the pre-wash phase.

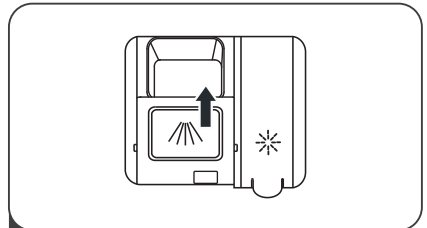

- 3** Close the flap by sliding it to the front and then pressing it down.

## NOTE:





- Be aware that depending on the soiling of water, setting may be different.
- Please observe the manufacturer's recommendations on the detergent packaging.

# PROGRAMMING THE DISHWASHER

## Wash Cycle Table

The table below shows which programs are best for the levels of food residue on them and how much detergent is needed. It also show various information about the programs.

(●) Means: need to fill rinse into the Rinse-Aid Dispenser.

Program	Description Of Cycle	Detergent Pre/Main	Running Time(min)	Energy (Kwh)	Water (L)	Rinse Aid
 <b>Auto</b>	Pre-wash(45°C) Autowash (45-55°C) Rinse Rinse(65°C) Drying	$\frac{5}{28.75g}$ (1 piece)	150	0.9 -1.3	11-15	●
 <b>Intensive</b>	Pre-wash(50°C) Wash(60°C) Rinse Rinse Rinse(70°C) Drying	$\frac{5}{28.75g}$ (1 piece)	175	1.4	17.5	●
<b>ECO</b> (*AS/NZS 2007.1)	Pre-wash Wash(45°C) Rinse(45°C) Drying	$\frac{5}{28.75g}$ (1 piece)	195	0.65	12	●
 <b>Glass</b>	Pre-wash Wash(40°C) Rinse Rinse(60°C) Drying	$\frac{5}{28.75g}$ (1 piece)	130	0.75	13	●
 <b>90 min</b>	Wash(65°C) Rinse Rinse(65°C) Drying	$\frac{33.75g}$ (1 piece)	90	1.15	12.5	●
 <b>Rapid</b>	Wash(45°C) Rinse(55°C) Rinse(55°C)	20g	30	0.7	11	○

Program	Description Of Cycle	Detergent Pre/Main	Running Time(min)	Energy (Kwh)	Water (L)	Rinse Aid
 Soak	Prewash		15	0.02	4	○

## NOTE:

**AS/NZS 2007.1:** This program is the test cycle. The information for comparability test in accordance with AS/NZS 2007.1.

## Starting A Cycle Wash

1. Draw out the lower and upper basket, load the dishes and push them back. It is commended to load the lower basket first, then the upper one.
2. Pour in the detergent.
3. Insert the plug into the socket. The power supply refer to last page "Product fiche". Make sure that the water supply is turned on to full pressure.
4. Open the door, touch the Power button.
5. Choose a program, the response indicator will be lit. Then press the Start/pause button and close the door, the dishwasher will start its cycle.

## Changing The Program Mid-cycle

A wash cycle can only be changed if it has been running for a short time otherwise, the detergent may have already been released and the dishwasher may have already drained the wash water. If this is the case, the dishwasher needs to be reset and the detergent dispenser must be refilled. To reset the dishwasher, follow the instructions below:

1. Open the door a little to stop the dishwasher, after the spray arm stop working, you can open the door completely.
2. Press Program button more than three seconds the machine will be in stand by state.
3. You can change the program to the desired cycle setting.
4. Press the Start/pause button and close the door , the dishwasher will start again.

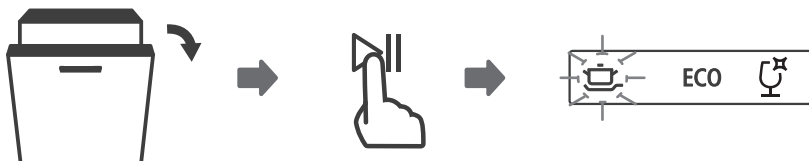

## Forget To Add A Dish?

A forgotten dish can be added any time before the detergent dispenser opens. If this is the case, follow the instructions below:

1. Open the door a little to stop the washing.
2. After the spray arms stop working, you can open the door completely.
3. Add the forgotten dishes.
4. Close the door.
5. The dishwasher will run after 10 seconds.

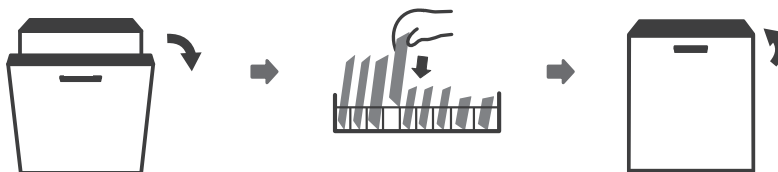

### **⚠ WARNING**



It is dangerous to open the door mid-cycle, as hot steam may scald you.



# ERROR CODES

If there is a malfunction, the dishwasher will display error codes to identify these:

Codes	Meanings	Possible Causes
E1	Longer inlet time.	Faucets is not opened, or water intake is restricted, or water pressure is too low.
E3	Not reaching required temperature.	Malfunction of heating element.
E4	Overflow.	Some element of dishwasher leaks.
E8	Failure of orientation of distributary valve.	Open circuit or break of distributary valve.
E9	Keep pressing a button more than 30 seconds.	Water or something on the button.
Ec	Washing control system fail.	PCB or motor fail.
Ed	Failure of communication between main PCB with display PCB	Open circuit or break wiring for the communication

## **⚠ WARNING**

- If overflow occurs, turn off the main water supply before calling a service.
- If there is water in the base pan because of an overflow or small leak, the water should be removed before restarting the dishwasher.

# TECHNICAL INFORMATION

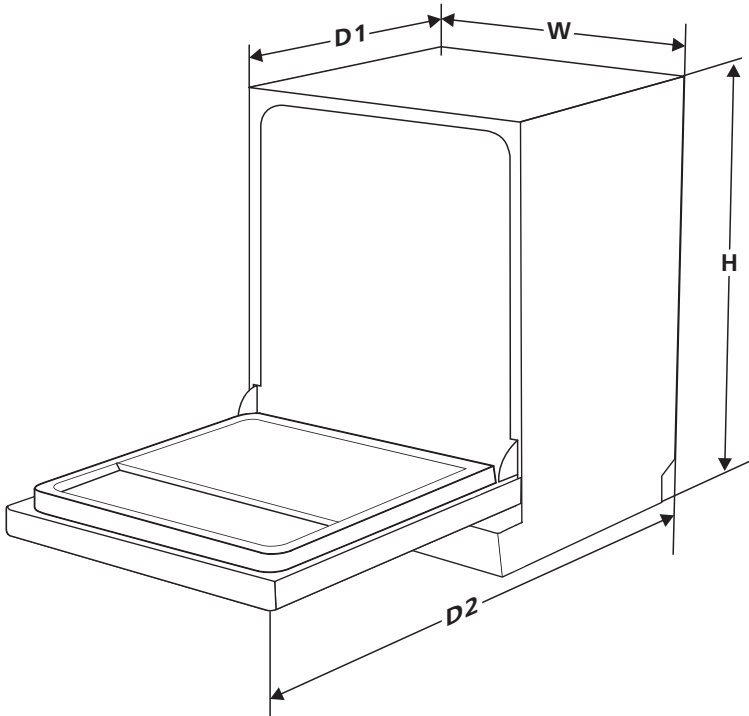

<b>Height (H)</b>	815mm
<b>Width (W)</b>	598mm
<b>Depth (D1)</b>	550mm (with the door closed)
<b>Depth (D2)</b>	1150mm (with the door opened 90° )

## Product fiche

Manufacturer	FRANKE	
Type / Description	FCDW60FI	
Standard place settings	15	
Energy efficiency class	★ ★ ★ ★ ☆ ☆	4
Water consumption class	★ ★ ★ ★ ★ ☆	5
Standard cleaning cycle	ECO	
Energy consumption of the standard cleaning cycle	0.65 kWh	
Water consumption of the standard cleaning cycle	12 liter	
Program duration of the standard cleaning cycle	195 min	
Noise level	47 dB(A) re 1 pW	
Mounting	built-in	
Could be built-in	YES	
Power consumption	1760-2100W	
Rated voltage / frequency	AC 220-240V/50Hz	
Water pressure (flow pressure)	0.04-1.0MPa=0.4-10 bar	