



# **Built-in Oven User Manual**

Model: FCE60P16B2

## Using This Manual

This Owner's Manual contains important information on safety and instructions intended to assist you in the operation and maintenance of your appliance.

Please take the time to read this Owner's Manual before using your oven and keep this book for future reference.

### The following symbols are used in the text of this Owner's Manual



**Important**



**Note**

## Safety Instructions

Installation of this oven must be performed only by a licensed electrician. The installer is responsible for connecting the appliance to the mains power supply in observance of the relevant safety recommendations.

### Electrical safety

If the oven has been damaged in transport, do not connect it.

- Appliance must be connected to the mains power supply only by a specially licensed electrician.
- In the event of a fault or damage to the appliance, do not attempt to operate it.
- Repairs should be performed by a licensed technician only. Improper repair may result in considerable danger to you and others. If your oven needs repair, contact a Service Centre or your dealer.
- If the supply cord is damaged, it must be replaced by the manufacturer, its service agent or similarly qualified persons in order to avoid a hazard.
- Electrical leads and cables should not be allowed to touch the oven.
- Install an omnipolar circuit-breaker with a minimum contact opening of 3 mm between the appliance and the mains. The omnipolar circuit breaker should be sized according to the load and should comply with current regulations (the earth wire should not be interrupted by the circuit breaker).
- The rating plate is located on the right side of the door.
- The power supply of the appliance should be turned off when it is being repaired or cleaned.
- Take care when connecting electrical appliances to sockets near the oven.

### WARNING

The appliance should be powered down before replacing the lamp to avoid the possibility of electric shock. During oven operation, the interior surfaces become very hot.

### Safety during operation

- This oven has been designed only for the cooking of household foods.
- During use, the oven interior surfaces become hot enough to cause burns. Do not touch heating elements or interior surfaces of the oven until they have had time to cool.
- Never store flammable materials in the oven.
- The oven surfaces become hot when the appliance is operated at a high temperature for an extended period of time.
- When cooking, take care when opening the oven door as hot air and steam can escape rapidly.
- When cooking dishes that contain alcohol, the alcohol may evaporate due to the high temperatures and the vapour can catch fire if it comes into contact with a hot part of the oven.
- For your safety, do not use high-pressure water cleaners or steam jet cleaners.
- Frozen foods such as pizzas should be cooked on the wire grill. If the baking tray is used, it may become deformed due to the great variation in temperatures.

- Do not pour water into the oven bottom when it is hot. This could cause damage to the enamel surface.
- The oven door must be closed during cooking.
- Do not line the oven bottom with aluminium foil and do not place any baking trays or tins on it. The aluminium foil blocks the heat, which may result in damage to the enamel surfaces and cause poor cooking results.
- Fruit juices will leave stains, which can become indelible on the enamel surfaces of the oven. When cooking very moist cakes, use the deep pan.
- Does not rest bake ware on the open oven door.
- Ensure that the appliance is switched off before replacing the lamp to avoid the possibility of electric shock.
- If a cooking time is not entered, the oven will shut itself off after the lengths of time indicated below.

### **Child safety**

- Children should be kept away unless continuously supervised.
- CAUTION- Some parts of this product can become very hot and cause burns. Particular attention has to be given where children and vulnerable people are present.
- Children shall not play with the appliance.
- Cleaning and user maintenance shall not be made by children.
- The appliance is not intended for use by persons (including children) with reduced physical sensory or mental capabilities, or lack of experience and knowledge, unless they have been given supervision or instruction concerning use of the appliance by a person responsible for their safety.
- Children should be supervised to ensure that they do not play with the appliance.
- Keep electrical appliances out of reach from Children or infirm persons. Do not let them use the appliances without supervision.
- WARNING: Accessible parts may become hot when the grill is in use. Children should be kept away.
- WARNING: Ensure that the appliance is switched off before replacing the lamp to avoid electric shock.
- Always place oven racks in desired location while oven is cool. If a rack must be moved while oven is hot, do not let potholder contact the heating elements.
- Always use dry potholders. Moist or damp potholders on hot surfaces may result in burns from steam. Do not let potholder touch hot heating elements. Do not use a towel or other bulky cloth.
- WARNING: Accessible parts may become hot during use. You children should be kept away.
- Secure all loose garments, etc. before beginning. Tie long hair so that it does not hang loose, and do not wear loose fitting clothing or hanging garments, such as ties, scarves, jewelry, or dangling sleeves.
- When children become old enough to use the appliance, it is the legal responsibility of the parents or legal guardians to ensure that they are instructed in safe operation of the appliance by qualified persons.
- Do not allow anyone to climb, stand, lean, sit, or hang on any part of an appliance, especially a door, warming drawer or storage drawer. This can damage the appliance, and the unit may tip over, potentially causing severe injury.
- WARNING: The appliance and its accessible surface parts become hot during use. Care shall be taken to avoid touching heating elements. Do not allow children to use this appliance. Children and pets should not be left alone or unattended in the area where the appliance is in use. They should never be allowed to play in its vicinity, whether or not the appliance is in use.

## Cleaning Safety

### CAUTION:

Items of interest to children should not be stored in an appliance, in cabinets above an appliance or on the backsplash. Children climbing on an appliance to reach items could be seriously injured.

Do not clean the appliance while it is still hot. Some cleaners produce noxious fumes when applied to a hot surface. Wet clothes or sponges can cause burns from steam.

#### Oven exterior

- For cleaning both the interior and exterior of the oven, use a cloth and a mild cleaning agent or warm soapy water.
- Dry with kitchen paper or a dry towel.
- Do not use scourers, caustic cleaners or abrasive products.

#### Stainless steel oven fronts

- Do not use steel wool, scouring pads or abrasives. They may damage the finish.
- Do not use harsh abrasive cleaners or sharp metal scrapers to clean the oven door glass or the glass of the hinged lid, since they can scratch the surface, which may result in shattering of the glass.

#### Aluminium oven fronts

- Wipe the plate gently with a soft cloth or microfiber cloth and a mild window cleaning detergent.

### WARNING

Make sure the oven is cool before cleaning.

#### Oven interior

- Do not hand- clean the door seal.
- Do not use coarse scouring pads or cleaning sponges.
- To avoid damaging the enameled oven surfaces, use commercially available oven cleaners.
- To remove stubborn soil, use a special oven cleaner.

#### Oven door glass

The oven door is equipped with three sheets of glass placed against each other. The inner & middle sheets can be removed for cleaning.

#### WARNING

- Whenever the door is separated from the oven, the clips should be flipped open.
- Do not use harsh abrasive cleaners or sharp metal scrapers to clean the oven door glass since they can cascratch the surface, which may resulting in shattering of the glass.
- When the door is mounted, removing some of the parts (the door glass or some other part) from the door may result in injury.

#### Attention

The glass may break if you use excessive force especially at the edges of the front sheet.

#### Accessories

Wash all bakeware and accessories after each use and dry with a kitchen towel. To clean easily, soak in warm soapy water for about 30 minutes.

#### Catalytic enamel surface

The removable cover casing is coated with a dark gray catalytic enamel that can become coated with oil and fat distributed by circulating air during convection heating. These deposits will burn off at oven temperatures of 200 °C and higher, for example, when baking or roasting.

Higher temperatures will result in faster burning. The oven and accessories should be cleaned after each use. Otherwise further baking and roasting will cause the deposits to bake on even harder and cleaning may become difficult and in extreme cases impossible.

### **Cleaning by hand**

Make sure the oven is cool before cleaning.

- The catalytic enameled cover casing should be cleaned using a solution of hot water and washing-up liquid applied with a soft nylon brush.

Do not use abrasive cleaning agents, hard brushes, scouring pads or cloths, steel wool, knives or other abrasive materials. Do not use oven spray on catalytic enamel as the chemicals used in oven sprays will damage catalytic enamel and render it ineffective.

If using oven sprays on the interior oven surfaces, the catalytic cover casing must first be removed from the oven.

### **Cleaning with high temperatures**

Before cleaning the catalytic cover casing with high temperatures, make sure that all interior oven surfaces have been cleaned as described above. Otherwise, the high temperatures can bake deposits onto the interior oven surfaces and make them impossible to remove.

If, after manual cleaning, the oven is still heavily soiled, heating it to a high temperature will help remove soiling caused by oil and grease splashes.

Note that deposits of spices, syrups and similar substances are not removed by this process. These should be removed by hand with a mild solution of hot water and washing-up liquid applied with a soft brush.

- Remove excess spillage before cleaning.
- Remove all accessories from the oven.
- Set the oven to conventional function.
- Set the heat to 250 °C.
- Run the oven for approximately 1 hour. The length of time will depend on the degree of soiling.

It is a good idea to set the finish time for the process using the end time setting, in case you forget to switch the oven off at the end.

Any remaining soil will gradually disappear with each subsequent use of the oven at high temperatures.

### **Disposal Instructions**

Disposing of the packaging material

- The material used to package this appliance is recyclable.
- Dispose of the packaging materials in the appropriate container at your local waste disposal facility Disposing of old appliances

### **WARNING**

Before disposing of old appliances, make them inoperable so that they cannot be a source of danger.

**To do this, disconnect the appliance from the mains supply and remove the mains lead.**

To protect the environment, it is important that old appliances are disposed of in the correct manner.

- The appliance must not be disposed of with household rubbish.
- You can obtain information about collection dates and public refuse disposal sites from your local refuse department or council.



Meaning of crossed -out wheeled dustbin:

Do not dispose of electrical appliances as unsorted municipal waste, use separate collection facilities.

Contact your local government for information regarding the collection systems available.

If electrical appliances are disposed of in landfills or dumps, hazardous substances can leak into the groundwater and get into the food chain,

damaging your health and well-being.

When replacing old appliances with new ones, the retailer is legally obligated to take back your old appliance for disposals at least free of charge.

## Installing the Oven

Electrical installation of this appliance must be performed only by a licensed electrician.



The oven must be installed according to the instructions supplied.

Remove the protective vinyl from the door after installation.

The oven must not be installed behind a decorative door in order to avoid overheating.

## Safety instructions for the installer

- Installation must guarantee protection against exposure to electrically live parts.

## Installation of Built-in Ovens

In order to ensure that the built-in appliance functions properly, the cabinet containing it must be appropriate. The figure below gives the dimensions of the cut-out for installation under the counter or in a wall cabinet unit.

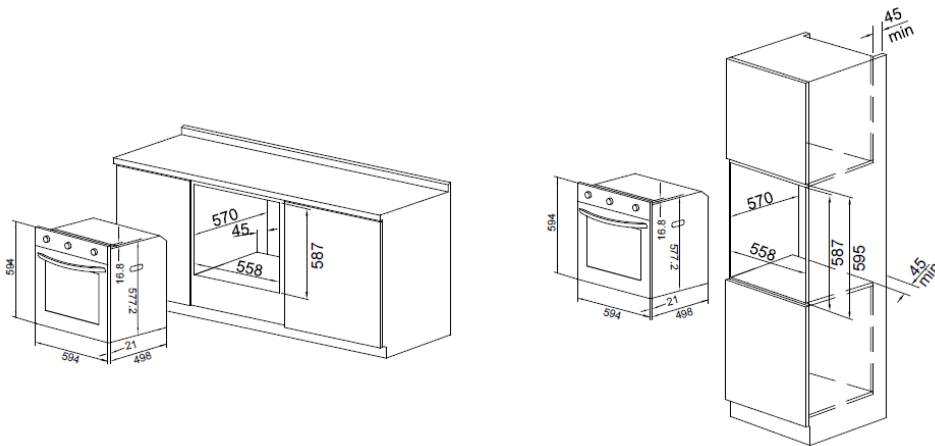

N. B :Installation in compliance with the consumption declaration

In order to ensure adequate ventilation, the back panel of the cabinet unit must be removed. Installing the oven so that it rests on two strips of wood is preferable. If the oven rests on a continuous, flat surface, there must be an aperture of at least  $45 \times 560$  mm.

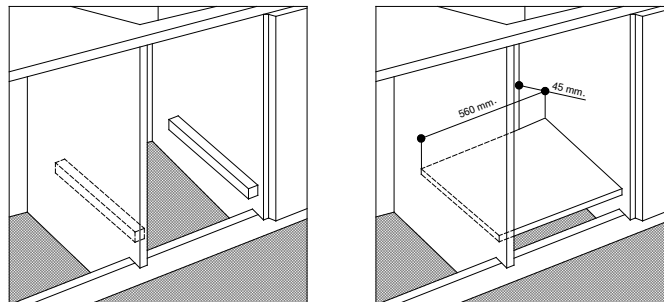

The panels of the adjacent cabinets must be made of heat-resistant material. In particular, cabinets with a veneer exterior must be assembled with glues which can withstand temperatures of up to  $100^{\circ}\text{C}$ .

In compliance with current safety standards, contact with the electrical parts of the oven must not be possible once it has been installed.

All parts, which ensure the safe operation of the appliance, must be removable only with the aid of a tool.

To fasten the oven to the cabinet, open the door of the oven and attach it by inserting the 4 wooden screws into the 4 holes located on the perimeter of the frame.

## Electrical Connection

Those ovens equipped with a three-pole power supply cable are designed to operate with an alternating current. The wire for earthing the appliance is yellow-green in color.

## Fitting on a Power Supply Cable

Opening the terminal board:

- Using a screwdriver ,prize the bolt on the side tabs of the terminal board cover ;
- Using a screwdriver unhooking the no.2fixing hooks, pull open the cover of the terminal board.

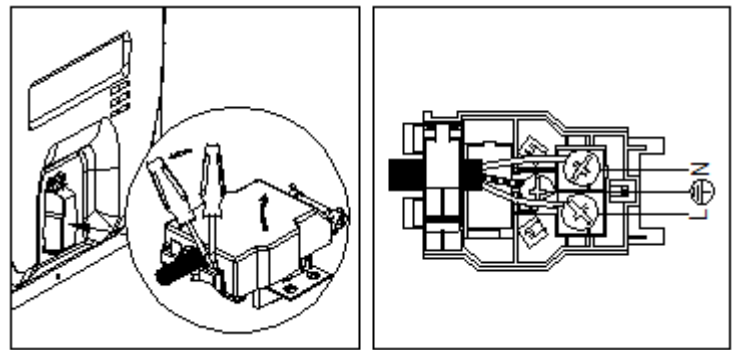

To install the cable, proceed as follows:

- Remove the wire clamp screw and the three contact screws L-N  $\perp$
- Fasten the wires beneath the screw heads using the following color scheme :Blue (N) Brown (L) Yellow-Green  $\perp$
- Fasten the supply cable in place with the clamp and close the cover of the terminal board .

### Connecting the supply cable to the mains

Install a standardized plug corresponding to the load indicated on the data plate. When connecting the cable directly to the mains, install an omni polar circuit breaker with a minimum contact opening of 3 mm between the appliance and the mains .The omni polar circuit breaker should be sized according to the load and should comply with current regulations (the earth wire should not be interrupted by the circuit breaker).

The supply cable should be positioned so that it does not reach a temperature of more than 50°C with respect to the room temperature ,anywhere along its length , or protected by insulation sleeping having an appropriate rating.

Before making the connection, check that:

- The electrical safety of this appliance can only be guaranteed if the cooker is correctly and efficiently earthed ,in compliance with regulations on electrical safety. Always ensure that the earthling is efficient; if you have any doubts call in a qualified technician to check the system .The manufacturer declines all responsibility for damage resulting from a system which has not been earthed.
- Before plugging the appliance into the mains ,check that the specifications indicated on the date plate (on the appliance and /or packaging )correspond to those of the electrical mains system of your home .
- Check that the electrical capacity of the system and sockets will support the maximum power of the appliance ,as indicated on the data plate .If you have any doubts, call in a qualified technician.
- If the socket and appliance plug are not compatible ,have the socket replaced with a suitable model by a qualified technician . The latter, in particular, will also have to ensure that the cross section of the socket cables are suitable for the power absorbed by the appliance. The use of adapters, multiple sockets and /or extensions, is not recommended. If their use cannot be avoided, remember to use only single or multiple adapters and extensions which comply with current safety regulations .In these cases, never exceed the maximum current capacity indicated on the single adapter or extension and the maximum power indicated on the multiple adapter .The plug and socket must be easily accessible.

## Parts and Features

### Oven

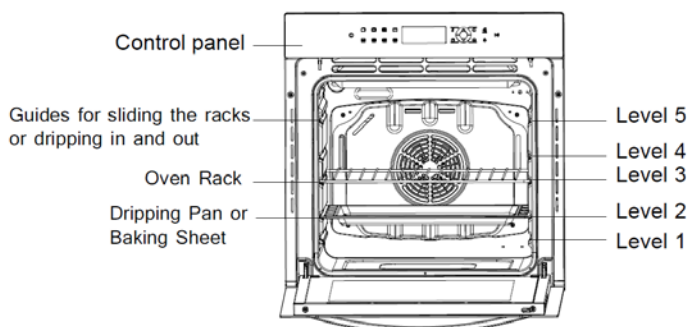

Shelf levels are numbered from the bottom up.

Levels 4 and 5 are used mainly for the grill function.

Please refer to the cooking guides provided throughout this manual to determine appropriate shelf levels for your dishes.

## Special features

**Probe** (an optional choice for customers) : These modes can't use it 

There is a Probe Outlet to match with the Probe.

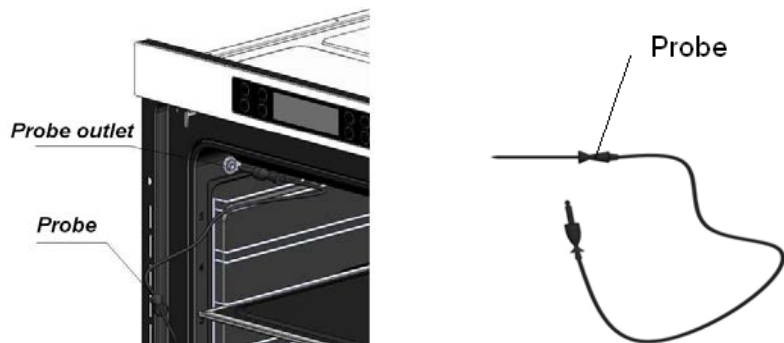

### How to set the oven for roasting when using the probe

- Insert the probe into the meat.
- Plug the probe into the outlet in the oven. Make sure it is pushed all the way in. If the Probe is inserted correctly,  will show on the display.
- Close the oven door.
- Select the function you need.
- Touch the **Temperature Button**, the oven temperature will show on the display, you can use the **Temp / Function Adjust Button** to set the desired oven temperature, in 5°C increments, from 40°C to 260°C.
- Touch the **Temperature Button** again, the Probe temperature will show on the display, you can use the **Temp / Function Adjust Button** to set the Probe temperature, in 5°C increments, from 40°C to 95°C.
- Press the **Start/Stop Button**, and then the oven starts working.
- When the internal temperature of the meat reaches the number you have set, the probe and the oven turn off, 'End' will show in the display and the oven control will beep.

### Accessories (optional accessories, the actual shall prevail)

The following accessories are provided with your oven.



1. **Wire grill**, for dishes, cake tins, roasting and grilling trays.



2. **Wire roast**, for roasting





3. **Baking tray**, for cakes and biscuits.



4. **Deep pan**, and roasting or collecting meat juices or fat drippings.

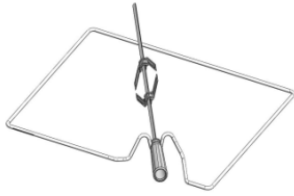





**5. Rotisserie spit** (only can be used in these two modes:   )

The baking tray, deep pan and wire grill should be inserted correctly into the side runners. When taking out the cooked foods from the oven, be careful of hot utensils and surfaces.

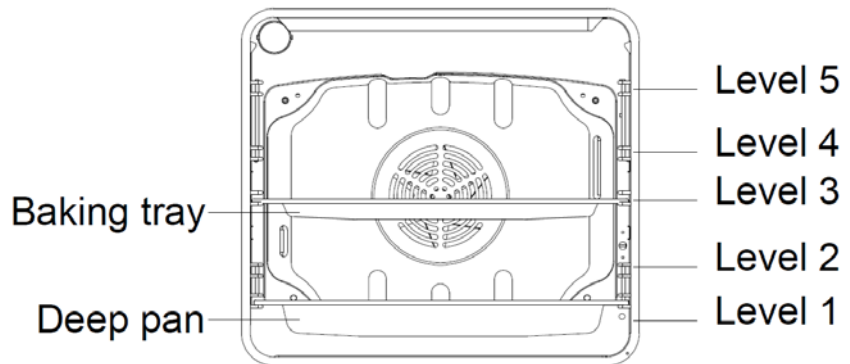
Example Level 1: Deep pan  
Level 3: Baking tray



 When using the deep pan or the baking tray to collect drippings from cooking foods, ensure that the pan or tray is properly placed in the side runners. Allowing these accessories to contact the bottom surface of the oven can damage the enamel of the surface. Trays and pans placed on level 1 should clear the bottom surface of the oven by at least 2 cm.

### Safety shutoff

If a cooking time is not entered, the oven will shut itself off after two hours.

- This oven's electrical circuitry features a thermal shutoff system. If the oven heats to abnormally high temperatures, the system will shut off the power supply to the heating elements for a period of time or oven for all along.

### Cooling Ventilation

To cool the oven outer layer, and some models equipped with a cooling fan. When the oven gets hot, the cooling fan is automatically enabled.

When the fan is on, between the oven door and the control panel will appear normal airflow.

**Note: After baking, the oven fan has been working to cool sufficiently.**

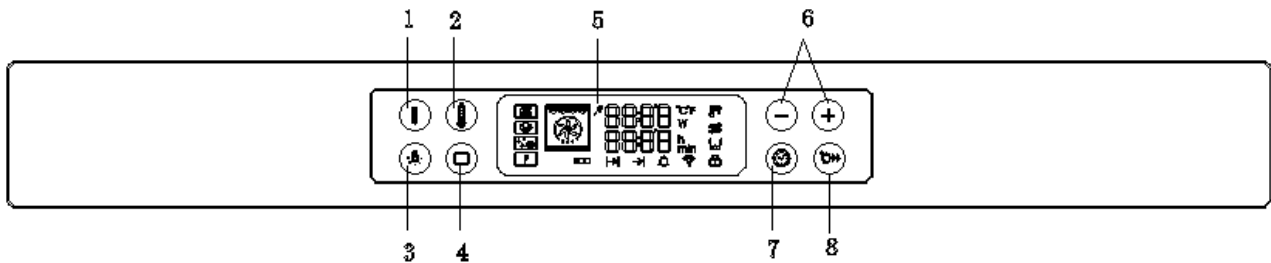

- |                   |  |
|-------------------|--|
| 1. On/Off Button  | 2. Temperature Button                  |
| 3. Light Button   | 4. Function Button                     |
| 5. Window Display | 6. Time / Temp/ Function Adjust Button |
| 7. Time Button    | 8. Rapid Heating Button                |

## Before You Begin

### Setting the clock

When power is first supplied to the oven, the display on the control panel will light briefly and 12:00 will appear in the display. Can only set the clock in the oven to standby mode.

- 1 "0: " will blink in the display when power is first supplied to the appliance and shows the set hour.
- 2 Touch the **Time / Temp / Function Adjust Button** "+" or "-" to set the hour of the day.  
Example: to set 1:30.  
Wait for about 5 seconds, The clock stops blinking and show the set hour.
- 3 Press the **Time Button** . The " :00" will blink.
- 4 Touch the **Time / Temp / Function Adjust Button** "+" or "-" to set the minute of the time.
- 5 Long press the **Time Button** to finish setting the clock or wait for about 5 seconds. The " :30" will stop blinking. The display shows the time of day. The appliance is now ready to use.

### Initial cleaning

Clean the oven thoroughly before using for the first time.



Do not use sharp or abrasive cleaning materials. These could damage the oven surface. For ovens with enamel fronts, use commercially available cleaning agents.

### To clean the oven

1. Open the door, the oven lights comes on by touching the **Light Button**.
2. Clean all oven trays, accessories and side runners with warm water or washing up liquid and polish dry with a soft clean cloth.
3. Clean the oven interior with a soft clean cloth.
4. Wipe the front of the appliance with a damp cloth.

Check that the clock is set correctly. Remove accessories and operate the oven at the convection setting at 200 °C for 1 hour before using.

There will be a distinctive odor; this is normal,



but ensure your kitchen is well ventilated during this conditioning period.

## Oven use

### Setting the oven function

Switch on the oven by touch "**On/Off**" **Button**, then select the mode you want. For further details, see the table below.

- 1 Switch on the oven by touch "**On/Off**" **Button**.
- 2 Touch the **Time / Temp/ Function Adjust Button** "+" or "-" to select the desired oven function. If 3 seconds have elapsed and there are no further adjustments, the oven will begin automatically in the selected mode and function.

 If you want to change the partition, Touch the **Function Button**  and hold for about 3 seconds, then touch the **Time / Temp / Function Adjust Button** "+" or "-" to select the desired function.

### Setting the oven temperature

- 1 Touch the **Temperature Button**  and hold for about 3 seconds, the temperature will flash.
- 2 Touch the **Time / Temp / Function Adjust Button** "+" or "-" to adjust the temperature in increments of 5 °C.

 **The temperature may be adjusted during cooking.**

### Switching the Oven On/Off



To switch the oven on/off, touch the **On/Off Button**.

### Switching the Light On/Off

To switch the light on/off, touch the **Light Button**.



### End time

You can set the end time during cooking.

1. Touch the **Time Button**  several times until the end time icon and the three digits on the display begin to flash.
2. Touch the **Time / Temp / Function Adjust Button** "+" or "-" to set the desired end time.
3. The oven operates with the selected end time automatically after press the **Time Button**  or wait for about 3 seconds.



### Cook time

You can set the cook time during cooking.



1. Touch the **Time Button**  several times until the end time icon and the three digits on the display begin to flash.
2. Touch the **Time / Temp / Function Adjust Button** "+" or "-" to set the desired cook time.
3. The oven operates with the selected cook time automatically after press the **Time Button**  or wait for about 3 seconds.

### Delayed start





If the end time is entered after the cook time has already been set, the cook time and the end time are calculated and if necessary the oven sets a delayed start point.

1. Touch the **Time Button**  .  
Example : Current time is 3:00 and the desired cook time is 5 hours.
2. Touch the **Time / Temp / Function Adjust Button** "+" or "-" to set the end time.  
Example: You want to cook for 5 hours and finish at 8:30.
3. Touch the **Time Button**  . The oven is inoperable until the delayed start point.

### Kitchen timer

1. Touch the **Timer Button**  several times until " " icon and the three digits on the display begin to flash.
2. Touch the **Time / Temp / Function Adjust Button** "+" or "-" to set the desired time.
3. Touch the **Timer Button**  to start the kitchen timer. When the set time has elapsed, an audible signal sounds.

### Child safety function

- 1 Touch the **Time Button**  and **Function Button**  at the same time and hold for 3 seconds.  icon will appear in the display.
- 2 Press the **Time Button**  and **Function Button**  at the same time and hold for 3 seconds again to unlock.

### Quick baking

In an oven function is set to finish later, with the use of rapid baking function, the empty oven can be preheated in a short time.

Important: before the completion of the fast and oven baking function using the desired function is running, do not put food into the oven for

baking.

1 Set the desired oven function, if necessary, change the recommended temperature.

2 Press the key to rapid baking . One audible voice sounded.

When the temperature reached. One audible voice sounded.

Now follow the pre-set oven function and temperature continues to heat and now you can put the food into the oven.



If you want to cancel the quick baking, press the key to rapid baking , three audible voices sounded.

## Memory function

The Memory function can be used to save a setting which is frequently used.

1. Set oven function, temperature and if necessary the clock functions (Cook time and/or End time).

2. Press and hold the button  for approx. 2 seconds, until an acoustic signal sounds. The setting is saved.

To save another setting, press the button  for approx. 2 seconds. The previously saved setting is replaced by the new one.

### Starting the Memory function

1. Oven in standby mode, press and hold the button  for approx. 3 seconds into the memory function.

2. Press and hold the button  for approx. 3 seconds again, Memory function is obtained.

3. Wait for 5 seconds, memory function open.

## Oven functions

### Convection Mode

The top and bottom heating elements come on. This is the classic, traditional type of oven which has been perfected, with exceptional heat distribution and reduced energy consumption. The convection oven is still unequalled when it comes to cooking dishes made up of several ingredients, e. g. cabbage with ribs, Spanish style cod, Ancona style stockfish, tender veal strips with rice, etc. Excellent results are achieved when preparing veal or beef-based dishes as well (braised meats, stew, goulash, wild game, ham etc.) which need to cook slowly and require basting or the addition of liquid. It nonetheless remains the best system for baking cakes as well as fruit and cooking using covered casserole dishes for oven baking. When cooking in convection mode, only use one dripping pan or cooking rack at a time, otherwise the heat distribution will be uneven. Using the different rack heights available, you can balance the amount of heat between the top and the bottom of the oven. Select from among the various rack heights based on whether the dish needs more or less heat from the top.

### Fast cooking Mode

The top and bottom heating elements, as well as the fan, will come on, guaranteeing constant heat distributed uniformly throughout the oven. This mode is especially recommended for cooking prepacked food quickly (as pre-heating is not necessary), such as for example: frozen or pre-cooked food) as well as for a few "home-made" dishes.

The best results when cooking using the "Fast cooking" mode are obtained if you use one cooking only (the second from the bottom), please see the table entitled "Practical Cooking Advice".

### Multi-Cooking Mode

The top, circle and bottom heating elements, as well as the fan, will come on alternately. Since the heat remains constant and uniform throughout the oven, the air cooks and browns food uniformly over its entire surface. With this mode, you can also cook various dishes at the same time, as long as their respective cooking temperatures are the same. A maximum of 2 racks can be used at the same time, following the instructions in the section entitled: "Cooking On More Than One Rack".

This cooking mode is particularly recommended for dishes requiring a gratin finish or for those requiring considerably prolonged cooking times, such as for example: lasagne, pasta backs, roast chicken and potatoes, etc.. Moreover the excellent heat distribution makes it possible to use lower temperatures when cooking roasts. This results in less loss of juices, meat which is more tender and a decrease in the loss of weight for the roast. The Multi-cooking mode is especially suited for cooking fish, which can be prepared with the addition of a limited amount of

condiments, thus maintaining their flavor and appearance. Excellent results can be attained when cooking vegetable-based side dishes like courgettes, aubergines, peppers, etc...

Desserts: this mode is also perfect for baking leavened cakes.

Moreover, this mode can also be used to thaw quickly white or red meat and bread by setting the temperature to 80°C. To thaw more delicate foods, set the thermostat to 60°C or use only the cold air circulation feature by setting the thermostat to 0°C.

### **Pizza Mode**

The bottom and circle heating elements, as well as the fan, will come on. This combination rapidly heats the oven due to the large amounts of power used by the appliance, which results in the production of considerable heat coming prevalently from the bottom.

The pizza mode is ideal for foods requiring high temperatures to cook, like pizzas and large roasts. Only use one oven tray or rack at a time. However, if more than one is used, these must be switched halfway through the cooking process.

### **Delicate cooking**

The bottom heating element and the fan come on. Suitable for pastries, cakes and non-dry sweets in baking tins or moulds. Excellent results are also obtained in cooking requiring above all heat from the bottom.

You are advised to put the pan on a low level.

### **Fast Preheat Mode**

The top and circle heating elements, as well as the fan, will come on. To fast preheat the oven before baking, this function can be activate to preheat.

Fast Preheat enables advanced convection cooking function without having to turn the food, giving crispy great tasting results in a shorter time without all the oil. This is suitable for french fries, chicken wings, nuggets and similar products.

### **Grill Mode**

The top central heating elements comes on.

“Grill” directs radiant heat from the powerful upper element onto the food. You can use the “Grill” function for tender cuts of meat, steak, chops, sausages, fish, cheese toasties and other quick cooking foods. Grill with the oven door closed. Preheat your grill for 3 minutes to get the best results. This will help seal in the natural juices of steak, chops etc. for a better flavour. You can slide your grill dish into either of the 2 spaces within the upper pairs of support rails.

### **Maxi Grill Mode**

The top inside and outside heating elements comes on. “Maxi grill” directs radiant heat from 2 powerful upper elements onto the food. You can use the “Maxi grill” function for tender cuts of meat, steak, chops, sausages, fish, cheese toasties and other quick cooking foods. Grill with the oven door closed. “Maxi grill” allows you to take full advantage of the large grill dish area and will cook faster than normal “Grill”. For best results it is recommended to preheat your grill for 3 minutes. This will help seal in the natural juices of steak, chops etc. for a better flavour.

### **Fan Assisted Grill**

The top heating elements and the fan come on. This combination of features increases the effectiveness of the unidirectional thermal radiation of the heating elements through forced circulation of the air throughout the oven. This helps prevent food from burning on the surface, allowing the heat to penetrate right into the food. Excellent results are achieved with kebabs made with meats and vegetables, sausages, ribs lamb chops, chicken in a spicy sauce, quail, pork chops, etc.

### **Cook food in "fan assisted grill mode" with the oven door shut.**

This mode is also ideal for cooking fish steaks, like swordfish, stuffed cuttlefish etc.

### **Baking Mode**

The rear heating element and the fan come on, guaranteeing delicate heat distributed uniformly throughout the oven.

This mode is ideal for baking and cooking delicate foods—especially cakes that need to rise—and for the preparation of certain tartlets on 3 shelves at the same time. Here are a few examples: cream puffs, sweet and savory biscuits, savoury puffs, Swiss rolls and small portions of

vegetables au gratin, etc. ...

### "Defrosting" Mode



The fan located on the bottom of the oven makes the air circulate at room temperature around the food. This is recommended for the defrosting of all types of food, but in particular for delicate types of food which do not require heat, such as for example: ice cream cakes, cream or custard desserts, fruit cakes .By using the fan, the defrosting time is approximately halved. In the case of meat, fish and bread, it is possible to accelerate the process using the "Baking" mode and setting the temperature to 80°C-100°C.

### Energy saving baking mode

The rear heating element and the fan come on, guaranteeing delicate heat distributed uniformly throughout the oven. Heating tube of intermittent work make full use of the heat within the furnace chamber, can reduce energy losses, to achieve the effect of energy saving. This mode is ideal for baking and cooking delicate foods—especially cakes that need to rise—and for the preparation of certain tartlets on 3 shelves at the same time. Here are a few examples: cream puffs, sweet and savory biscuits, savoury puffs, Swiss rolls and small portions of vegetables au gratin, etc. ...

### The turnspit (only available on certain models)

To start the turnspit, proceed as follows:

- place the oven tray on the 1st rack ;
- insert the special turnspit support on the level 3 and position the spit by inserting it through the special hole into the turnspit at the back of the oven ;
- Press the **Temp/ Function Adjust Button** "+" or "-" to select setting  

## Cleaning and Care

### Cleaning the oven door

For normal use, the oven door should not be removed but if removal is necessary, for example, for cleaning, follow these instructions. The oven door is heavy.

How to Remove the Oven door

For a more thorough clean, you can remove the oven door. Choose the remove and assemble method. Proceed as follows:

Oven door structures 1 remove and assemble procedure:

- Open the door to the full extent(fig.1);
- Open the lever A completely on the left and right hinges(fig.2);
- Hold the door as shown in fig.3
- Gently close the door(fig.3)until left and right hinge levers A are hooked to part B of the door(fig.4).
- withdraw the hinge hooks from their location following arrow C(fig.4);

Rest the door on a soft surface;

- To replace the door, repeat the above steps in reverse order.

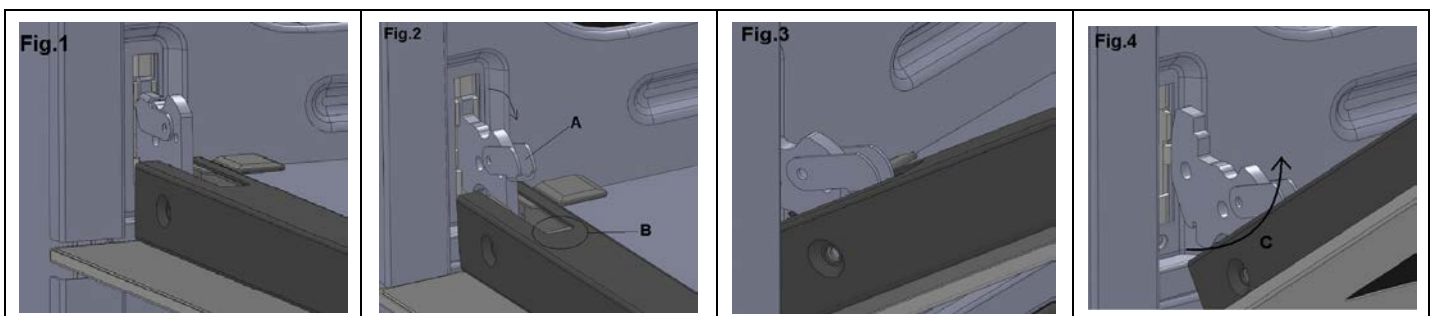

## Removing the Inner Pane of Glass

- Double oven door: Remove the seal G by unscrew the no.2 bolts (fig.1)
- Gently pull out the inner pane of glass(fig.2)
- Clean the glass with an appropriate cleaner. Dry thoroughly, and place on a soft surface.
- Now you can also clean the inside of the outer glass.

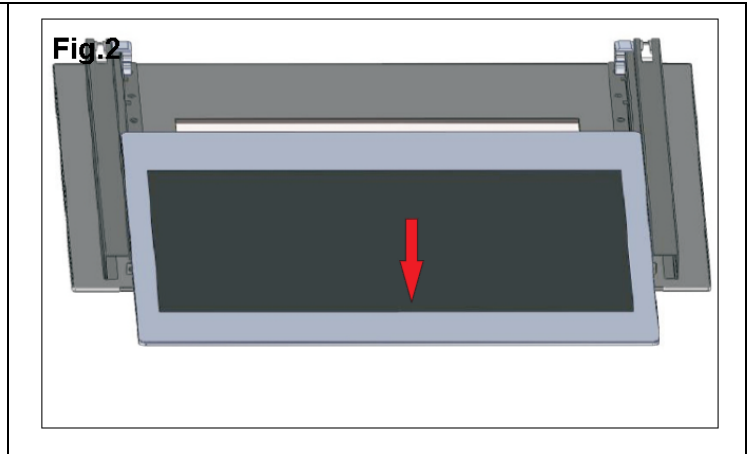
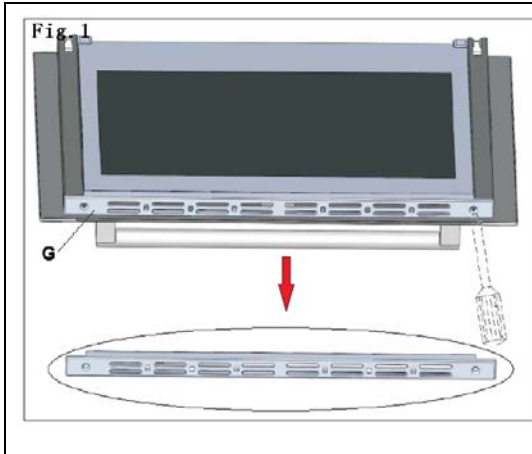

## Automatic cleaning “ P ”

Choose the self clean function, since the clean has three time can choose:

Standard	Degree of self-cleaning	Duration
1	Low	Approx. 2 hours
2	Medium	Approx. 2.5 hours
3	Strongly	Approx. 3 hours

## What we should know

For safety reasons, the oven locks automatically when the oven to start working. You will only be able to open the door again once the temperature has fallen below 250 °C.

The exterior of the oven will become very hot. Make sure that nothing is placed against the front panel.

Keep children at a safe distance.

Never attempt to open the oven during the self-cleaning process. The cleaning process may be interrupted.

Please do not attempt to push in the latch by hand.

You cannot switch the oven light on during self-cleaning.

## Before self-cleaning

Remove unsuitable accessories and all ovenware from the oven.

Risk of fire. Loose food residue, grease and meat juices are flammable.

Wipe the oven and the accessories that are to be cleaned at the same time with a damp cloth.

Clean the door and along the edges of the oven around the seal. Do not scour the seal.

Make sure that the oven door is closed before you start cleaning.

## Cleaning accessories at the same time

The wire grill is not suitable for self-cleaning.

Never clean metal sheets and dishes which have been coated with a non-stick coating using the oven's automatic self-cleaning function ( pyrolysis operation).

High temperatures can cause poisonous gases to be formed from the non-stick coating-risk of serious damage to health.

### Select the self-cleaning function

1 Select the self-cleaning function

- A suggested **level** appears on the temperature display.
- Press and hold the button  for approx. 3 seconds, the oven begins to heat.

2. Touch the **Time / Temp /Function Adjust Button** "+" or "-" to set the desired duration.

### Steam Assisted Cleaning function “ ”

This function assists in the removal of food residue from inside the oven. This method is effective in removing light soiling only. It is not effective in removing stubborn baked-on stains. This function can only be used when the oven is cold.

Procedure for cleaning

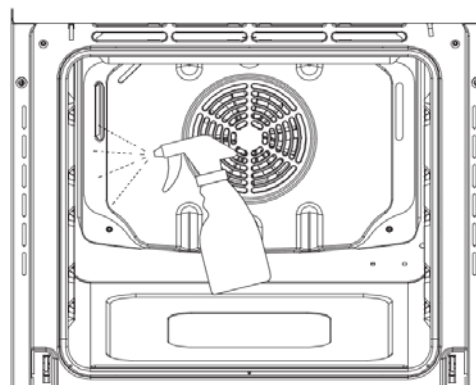

1. Remove all shelves, dishes and side racks.
2. Make a solution of water (85%), white vinegar (10%), and dish washing detergent (5%) and spray liberally on to door, side walls and back wall of oven cavity.
3. Pour 40ml of water into the cavity base well.
4. Close the door. Set the function to Steam Assist Clean and set the temperature to 130°C.
5. Turn oven OFF after 18 minutes.
6. Allow to cool to a safe level before wiping surface with a wet cloth.



## Practical Cooking Advice

The oven offers a wide range of alternatives which allow you to cook any type of food in the best possible way. With time you will learn to make the best use of this versatile cooking appliance and the following directions are only a guideline which may be varied according to your own personal experience.

### Cooking on More Than One Rack

If you have to cook food using several racks, use either the "**baking**" mode  or the "**Multi-Cooking**" mode  , as these are the only modes that allow you to do so.

When cooking delicate food on more than one rack, use the "**baking**" mode, which allows you to cook on 3 racks at the same time (the 1st 3rd and 5th from the bottom). Some examples are included in the "Practical Cooking Advice" table.

When cooking other food on several racks, use the "**Multi-Cooking**" mode keeping the following suggestions in mind:





- The oven is fitted with 5 racks. During fan assisted cooking, use two of the three central racks; the lowest and highest racks receive the hot air directly and therefore delicate foodstuffs could be burnt on these racks.
- As a general rule, use the 2nd and 4th rack from the bottom, placing the foodstuffs that require greater heat on the 2nd rack from the bottom. For example, when cooking meat roasts together with other food, place the roast on the 2nd rack from the bottom and the more delicate food on the 4th rack from the bottom.
- When cooking foodstuffs that require differing times and temperatures, set a temperature that is somewhere between the two temperatures required, place the more delicate food on the 4th rack from the bottom and take the food requiring less time out of the oven first.
- Use the dripping pan on the lower rack and the grid on the upper ;

### Using the "Fast Cooking" Mode

Functional, fast and practical for those of you who use pre-packed products (such as for example: frozen or pre-cooked food) along with other food items. You will find useful suggestions in the "Practical Cooking Advice" table.

### Using the Grill

This multi-function oven offers you 2 different grilling modes.

Use the "Grill / Maxi Grill" mode  /  placing the food under the center of the grill (situated on the 3rd or 4th rack from the bottom) because only the central part of the top heating element is turned on .

Use the bottom rack (1st from the bottom), placing the dripping pan provided to collect any sauce and /or grease and prevent the same from dripping onto the oven bottom. When using this mode, we recommend you set the thermostat to the highest setting. However, this does not mean you cannot use lower temperatures, simply by adjusting the thermostat knob to the desired temperature.

Setting  "fan assisted grill", is extremely useful for grilling foods rapidly, as the distribution of heat makes it possible not only to brown the surface, but also to cook the bottom part .

Moreover, it can also be used for browning foods at the end of the cooking process, such as adding that gratin finish to pasta bakes, for example.

When using this mode, place the grid on the 2nd or 3rd oven rack from the bottom (see cooking table ) then, to prevent fat and grease from dripping onto the bottom of the oven and thus smoke from forming, place a dripping-pan on the 1st rack from the bottom.

When using this mode, we advise you to set the thermostat to 200°C, as it is the most efficient way to use the grill, which is based on the use of infrared rays. However, this does not mean you cannot use lower temperatures, simply by adjusting the thermostat knob to the desired temperature.

**Therefore the best results when using the grill modes are obtained by placing the grid on the lower racks (see cooking table) then, to prevent fat and grease from dripping onto the bottom of the oven and smoke from forming, place a dripping-pan on the 1st oven rack from the bottom.**

### Baking Cakes

When baking cakes, always place them in a preheated oven. Make sure you wait until the oven has been preheated thoroughly. Do not open the oven door during baking to prevent the cake from dropping. In general:

#### Pastry is too dry

Increase the temperature by 10°C and reduce the cooking time .

#### Pastry dropped

Use less liquid or lower the temperature by 10°C .

### Pastry is too dark on top

Place it on a lower rack, lower the temperature, and increase the cooking time.

### Cooked well on the inside but sticky on the outside

Use less liquid, lower the temperature, and increase the cooking time.

### The Pastry sticks to the pan

Grease the pan well and sprinkle it with a dusting of flour or use greaseproof paper.

### I used more than one level (in the function "ventilated oven") and they are not all at the same cooking point

Use a lower temperature setting. It is not necessary to remove the food from all the racks at the same time.

### Cooking Pizza

For best results when cooking pizza, use the "Pizza Mode"  :

- Preheat the oven for at least 10 minutes ;
- Use a light aluminum pizza pan, placing it on the grid supplied with the oven. If the dripping pan is used, this will extend the cooking time, making it difficult to get a crispy crust;
- Do not open the oven door frequently while the pizza is cooking ;
- If the pizza has a lot of toppings (three or four ), we recommend you add the mozzarella cheese on top halfway through the cooking process .
- When cooking pizza on two racks, use the 2nd and 4th with a temperature of 220°C and place the pizzas in the oven after having preheated it for at least 10 minutes.



### Cooking Fish and Meat





When cooking white meat, fowl and fish, use temperature setting from 180°C to 200°C.



For red meat that should be well done on the outside while tender and juicy in the inside, it is a good idea to start with a high temperature setting (200°C-220°C) for a short time, then turn the oven down afterwards.

In general, the larger the roast, the lower the temperature setting. Place the meat on the center of the grid and place the dripping pan beneath it to catch the fat.

Make sure that the grid is inserted so that it is in the center of the oven. If you would like to increase the amount of heat from below, use the low rack heights. For savory roasts (especially duck and wild game), dress the meat with lard or bacon on the top.

Selector knob setting	Food to be cooked	Weight (in kg )	Cooking rack position from bottom	Preheating time (Minutes)	Thermostat knob setting	Cooking time (Minutes)
1 Convection 	Duck	1	3	15	200	65-75
	Roast veal or beef	1	3	15	200	70-75
	Pork roast	1	3	15	200	70-80
	Biscuits (short pastry)	-	3	15	180	15-20
	Tarts	1	3	15	180	30-35
2 Multi-Cooking 	Pizza (on 2 racks)	1	2-4	15	220	15-20
	Lasagna	1	3	10	200	30-35
	Lamb	1	2	10	180	50-60
	Roast chicken +potatoes	1	2-4	10	180	60-75
	Mackerel	1	2	10	180	30-35
	Plum-cake	1	2	10	170	40-50
	Cream puffs (on 2 racks)	0.5	2-4	10	190	20-25

	Biscuits (on 2 racks)	0.5	2-4	10	180	10-15
	Sponge cake (on 1 rack)	0.5	2	10	170	15-20
	Sponge cake (on 2 racks)	1.0	2-4	10	170	20-25
	Savory pies	1.5	3	15	200	25-30
<b>3 Grill</b> 	Soles and cuttlefish	1	4	5	Max	8-10
	Squid and prawn kebabs	1	4	5	Max	6-8
	Cod filet	1	4	5	Max	10
	Grilled vegetables	1	3/4	5	Max	10-15
	Veal steak	1	4	5	Max	15-20
	Cutlets	1	4	5	Max	15-20
	Hamburgers	1	4	5	Max	7-10
	Mackerels	1	4	5	Max	15-20
	Toasted sandwiches	-	4	5	Max	2-3
<b>4 Defrosting</b> 	All frozen food					
<b>5 Maxi Grill</b> 	Soles and cuttlefish	1	4	5	200	8-10
	Squid and prawn kebabs	1	4	5	200	6-8
	Cod filet	1	4	5	200	10
	Grilled vegetables	1	3/4	5	200	10-15
	Veal steak	1	4	5	200	15-20
	Cutlets	1	4	5	200	15-20
	Hamburgers	1	4	5	200	7-10
	Mackerels	1	4	5	200	15-20
	Toasted sandwiches	-	4	5	200	2-3
	<b>With rotisserie</b> (where prevent)					
	Veal on the spit	1.0	-	5	200	80-90
	Chicken on the spit	1.5	-	5	200	70-80
	Lamb on the spit	1.0	-	5	200	70-80
<b>6 Fan Assisted Grill</b> 	Grilled chicken	1.5	3	5	200	55-60
	Cuttlefish	1.5	3	5	200	30-35
	<b>With rotisserie</b> (where prevent)					
	Veal on the spit	1.5	-	5	200	70-80
	Chicken on the spit	2.0	-	5	200	70-80
	Chicken (on the spit)+potatoes (roasted)	1.5	-	5	200	70-75
		-	2	5	200	70-75
	Lamb on the spit	1.5	-	5	200	70-80
<b>7 Baking</b> 	Tarts	0.5	3	15	180	20-30
	Fruit cakes	1	2/3	15	180	40-45
	Fruitcake	0.7	3	15	180	40-50
	Sponge cake	0.5	3	15	160	25-30

	Stuffed pancakes) on 2 racks)	1.2	2-4	15	200	30-35
	Small cakes (On 2 racks)	0.6	2-4	15	190	20-25
	Cheese puffs (on 2 cakes)	0.4	2-4	15	210	15-20
	Cream puffs (on 3 cakes)	0.7	1-3-5	15	180	20-25
	Biscuits (On 3 racks)	0.7	1-3-5	15	180	20-25
	Meringues (On 3 racks)	0.5	1-3-5	15	90	180
<b>8 Fast cooking</b> 	<b>Frozen food</b>					
	Pizza	0.3	2	-	250	12
	Courgette and prawn pie	0.4	2	-	200	20
	Country style spinach pie	0.5	2	-	220	30-35
	Turnovers	0.3	2	-	200	25
	Lasagne	0.5	2	-	200	35
	Golden Rolls	0.4	2	-	180	25-30
	Chicken morseis	0.4	2	-	220	15-20
	<b>Pre-cooked food</b>					
	Golden chicken wings	0.4	2	-	200	20-25
	<b>Fresh Food</b>					
	Biscuits(short pastry)	0.3	2	-	200	15-18
	Fruitcake	0.6	2	-	180	45
	Cheese puffs	0.2	2	-	210	10-12
<b>9 Pizza</b> 	Pizza	0.5	3	15	220	15-20
	Roast veal or beef	1	2	10	220	25-30
	Chicken	1	2/3	10	180	60-70
<b>10 Fast Preheat</b> 	Scotch fillet steak, seared first	1	3	5	220	8
	Frozen chips	1	3	5	220	15
	Chicken drumettes/wingettes, with dry rub	1	3	5	230	15
	Fresh barramundi fillet with crumb	1	3	5	230	15
	Potatoes cut into wedges	0.5	3	5	230	14
	Frozen goods (Chicken nuggets/crumbed fish)	1	3	5	230	15
	Smashed chats parboiled	1.0	3	54	220	15

**NB:** cooking times are approximate and may vary according to personal taste. When cooking using the grill or fan assisted grill, the dripping pan must always be placed on the 1st oven rack from the bottom .

## Warranty & Service

### FAQs and Troubleshooting

On no account open the appliance housing!

Installation, maintenance and repairs may only be carried out by a suitably qualified and competent person in strict accordance with current national and local safety regulations.

Repairs and other work by unqualified persons could be dangerous. The manufacturer cannot be held liable for unauthorised work. Ensure

current is not supplied until after maintenance or repair work has been carried out.

Problem	Possible cause and remedy
The oven does not heat up	<ul style="list-style-type: none"> <li>- The oven may not be switched on. Switch the oven on.</li> <li>- The clock may not be set. Set the clock.</li> <li>- Check to see if the required settings have been applied.</li> <li>- A household fuse may have blown or a circuit breaker may have tripped. Replace the fuses or reset the circuit. If this happens repeatedly, call an authorised electrician.</li> </ul>
A noise can be heard after a cooking programme	The cooling fan remains switched on after the end of a cooking programme.
The lighting is not working	<ul style="list-style-type: none"> <li>■ Disconnect the appliance from the electricity supply: Switch off and unplug at the socket, or disconnect the fuse, or switch off at the isolator as appropriate.</li> <li>■ Turn the lamp turn anti-clockwise to release it and then pull it downwards to take it out.</li> <li>■ Replace it with a new halogen lamp.</li> <li>■ Refit the lamp cover and turn it clockwise to secure it.</li> <li>■ Reconnect the appliance to the mains electricity supply.</li> </ul>
Cakes and biscuits are browning unevenly	There will always be a slight unevenness. If browning is very uneven check that the correct temperature was set and that the correct shelf level was used.
A fault code appears in the display:HE1	<ul style="list-style-type: none"> <li>■ Temperature sensor error</li> <li>■ Call local service centre</li> </ul>
A fault code appears in the display:HE2	<ul style="list-style-type: none"> <li>■ Probe temperature sensor error</li> <li>■ Call local service centre</li> </ul>

### Technical Specifications

#### Inner dimensions of the oven:

Width 42.3cm

Depth 40.7cm

Height 39.2cm

#### Voltage and Frequency of Power Supply:

220-240V ~50/60Hz



1838-2151W



1822-2228W



1838-2151W



1838-2151W



2738-3251W



3038-3551W



938-1151W



1222-1428W



2122-2528W



2138-2551W



1838-2251W



1838-2151W

ECO



Franke Kitchen Systems

Services E-mail: [KS-AsiaExport.cn@franke.com](mailto:KS-AsiaExport.cn@franke.com)

[www.franke.com](http://www.franke.com)