

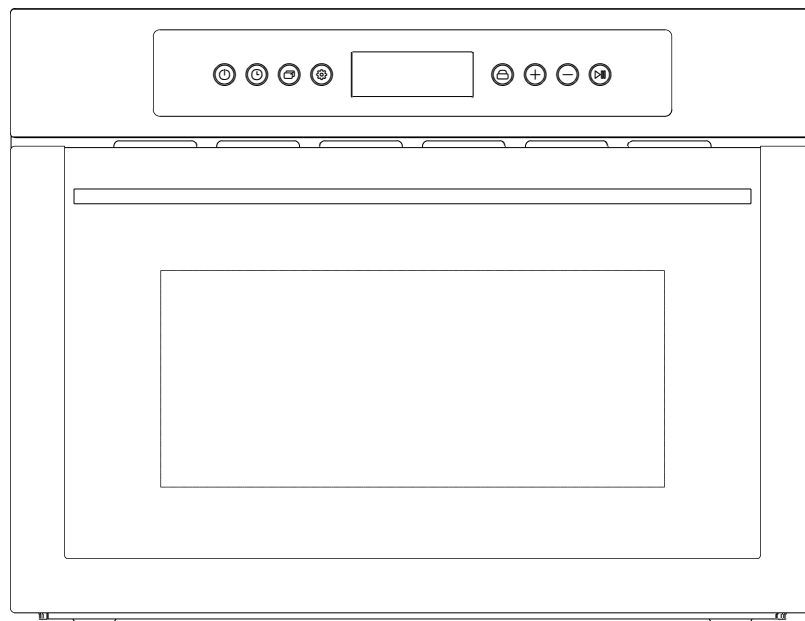

MODEL: FCMWC38B1

Built-in Microwave Oven

Owner's Manual



PRECAUTIONS TO AVOID POSSIBLE EXPOSURE TO EXCESSIVE MICROWAVE ENERGY

READ these instructions carefully before installing and operating the oven. Keep them for further reference.

1. Do not attempt to operate this oven with the door open since open door operation can result in harmful exposure to microwave energy. It is important not to defeat or tamper with the safety interlocks.
2. Do not place any object between the oven front panel and the door or allow soil or cleaner residue to accumulate on sealing surfaces.
3. Do not operate the oven if it is damaged. It is particularly important that the oven door closed properly and that there is no damage to the oven.
 - a) Door (bent),
 - b) Hinges and latches (broken or loosened),
 - c) Door seals and sealing surfaces.
4. The oven should not be adjusted or repaired by anyone except properly qualified service personnel.

CONTENTS

PRECAUTIONS TO AVOID POSSIBLE EXPOSURE TO EXCESSIVE MICROWAVE ENERGY.....	1
1.TECHNICAL SPECIFICATION	3
2.PRECAUTIONS FOR USE	3
3.SAFETY PRECAUTIONS	4
4.GET TO KNOW YOUR OVEN	5
5.BEFORE INSTALLATION.....	5
6.DESCRPTION OF FRONT PANEL CONTROL	6
7.USING THE OVEN.....	6
8.FUNCTIONS	6
9.RECOMMENDED BAKING MENU.....	11
10.CLEANING AND MAINTENANCE	15
11.SPECIAL MAINTENANCE.....	16
12.INSTALLING THE APPLIANCE.....	16
13.TROUBLE SHOOTING	19

1. TECHNICAL SPECIFICATION

MODEL	FCMWC38B1
CAPACITY (L)	35
VOLTAGE (V) /FREQUENCY (Hz)	220-240V~50/60 Hz
DISTRIBUTION LINE FUSE (A) /CIRCUIT BREAKER (A)	16
MICROWAVE INPUT WAVE (W)	1500-1600
MICROWAVE OUTPUT POWER (W)	1000
MICROWAVE WORKING FREQUENCY (MHz)	2450
GRILLING POWER (W)	1400-1650
CONVECTION POWER (W)	1350-1500
PRODUCT DIMENSION (mm)	594×580×455
PACKAGE SIZE (mm)	675×666×525
DIAMETER OF ROTATING PLATE (mm)	315
GROSS/NET WEIGHT (Kg)	38.0/34.3

2.PRECAUTIONS FOR USE

This manual is an integral part of the appliance. Take good care of it and keep it to hand throughout the oven's life cycle. We urge you to read this manual and all the information carefully before using the appliance. Installation should be carried out by qualified technician in compliance with the relevant regulations. This appliance is for household use and complies with the EEC directives currently in force. The appliance is for cooking and heating food.

The manufacturer declines all liability for other uses except for cooking food.

Keep the documentation of this product for future reference. Always keep the instruction manual handy. If you lend the microwave to someone else, the manual as well.



Never use this appliance for heating rooms.



Never leave packaging residues unattended in home. Separate the various packaging materials on type and consign them to the nearest separate disposal centre.



This manual contains the regulations of recycling decommissioned appliances.



Never obstruct vents provided for ventilation and heat dispersal.



Never use metal scouring pads or sharp scrapers which will damage the surface. Use ordinary non-abrasive products with the aid of wooden or plastic utensils if necessary. Rinse thoroughly and dry with a soft cloth or chamois leather.



The nameplate with the technical data, serial number and mark is in a visible position on the oven door frame.

The nameplate should never be removed.



The appliance should be connected to earth in compliance with electrical system safety regulations.



If a socket and plug connection is used, check that they are of the same type. Do not use reducers, adapters or junctions since they cause overheating or burns. the ac power supply must be 220-240V,50Hz,with a minimum 16A distribution line fuse, or a minimum 16A distribution circuit breaker.

3.SAFETY PRECAUTIONS

Please refer to the installation instructions for the safety regulations for electric or gas appliance and ventilation functions.

To ensure your safety, all electric appliance should only be installed and serviced by qualified staff, in accordance with the relevant regulations in law. Our approved installation engineers guarantee you a good service.

After installation, carry out a quick test on the oven referring to the instructions if the appliance fails to operate, disconnect it and contact the nearest service centre.

IMPORTANT SAFETY INSTRUCTIONS

READ CAREFULLY AND KEEP FOR FUTURE REFERENCE

- WARNING: If the door or door seals are damaged, the oven must not be operated until it has been repaired by a competent person;
- WARNING: It is hazardous for anyone other than a competent person to carry out any service or repair operation that involves the removal of a cover which gives protection against exposure to microwave energy;
- WARNING: Liquids and other foods must not be heated in sealed containers since they are liable to explode;
- WARNING: Accessible parts may become hot during use Young children should be kept away.
- WARNING: Only allow children to use the oven without supervision when adequate instructions have been given so that the child is able to use the oven in a safe way and understands the hazards of improper use;
- the minimum height 4 mm of free space necessary above the top surface of the oven;
- only use utensils that are suitable for use in microwave ovens;
- when heating food in plastic or paper containers, keep an eye on the oven due to the possibility of ignition;
- if smoke is observed, switch off or unplug the appliance and keep the door closed in order to stifle any flames;
- microwave heating of beverages can result in delayed eruptive boiling, therefore care must be taken when handling the container;
- the contents of feeding bottles and baby food jars shall be stirred or shaken and the temperature checked before consumption, in order to avoid burns;
- eggs in their shell and whole hard-boiled eggs should not be heated in microwave ovens since they may explode, even after microwave heating has ended;
- the oven should be cleaned regularly and any food deposits removed;
- failure to maintain the oven in a clean condition could lead to deterioration of the surface that could adversely affect the life of the appliance and possibly result in a hazardous situation;
- If the supply cord is damaged, it must be replaced by the manufacturer, its service agent or similarly qualified persons in order to avoid a hazard.
- This appliance is not intended for use by persons (including children) with reduced physical sensory or mental capabilities, or lack of experience and knowledge, unless they have been given supervision or instruction concerning use of the appliance by a person responsible for their safety.
- Children should be supervised to ensure that they do not play with the appliance.
- Warning: When the appliance is operated in the combination mode, children should only use the oven under adult supervision due to the temperatures generated.
- During use the appliance becomes hot. Care should be taken to avoid touching heating elements inside the Microwave oven.
- Do not use harsh abrasive cleaners or sharp metal scrapers to clean the oven door glass since they can scratch the surface, which may result in shattering of the glass.
- WARNING: The appliance and its accessible parts become hot during use. Care should be taken to avoid touching heating elements.
- Children shall be kept away unless continuously supervise.
- The appliance must not be installed behind a decorative door in order to avoid overheating.

– WARNING: Accessible parts may become hot during use. Young children should be kept away.

Avoid damage the oven or other dangerous situation according to the following instructions:

The microwave oven is intended for heating food and beverages. Drying of food or clothing and heating of warming pads, slippers, sponges, damp cloth and similar may lead to risk of injury, ignition or fire.

Care should be taken not to displace the turntable when removing containers from the appliance.

- Do not cover or obstruct the ventilation openings.
- Do not keep any inflammable object inside the oven as it may burn if the oven is switched on.
- Do not use the oven as a pantry.
- Do not pour spirits (e.g. brandy, whisky, schnapps, etc.) over hot food. Danger of explosion!
- Accessories such as wire racks and trays, etc. get hot in the cooking space. Always wear protective gloves or use oven clothes.
- To avoid being burnt, always use oven gloves for handling dishes and containers and touching the oven.
- Do not lean on the opened oven door. This may damage the oven, especially in the hinge zone. The door can bear a maximum weight of 8 kg.
- The racks can bear a maximum load of 8 kg. To avoid damaging the oven, do not exceed this load.

4.GET TO KNOW YOUR OVEN

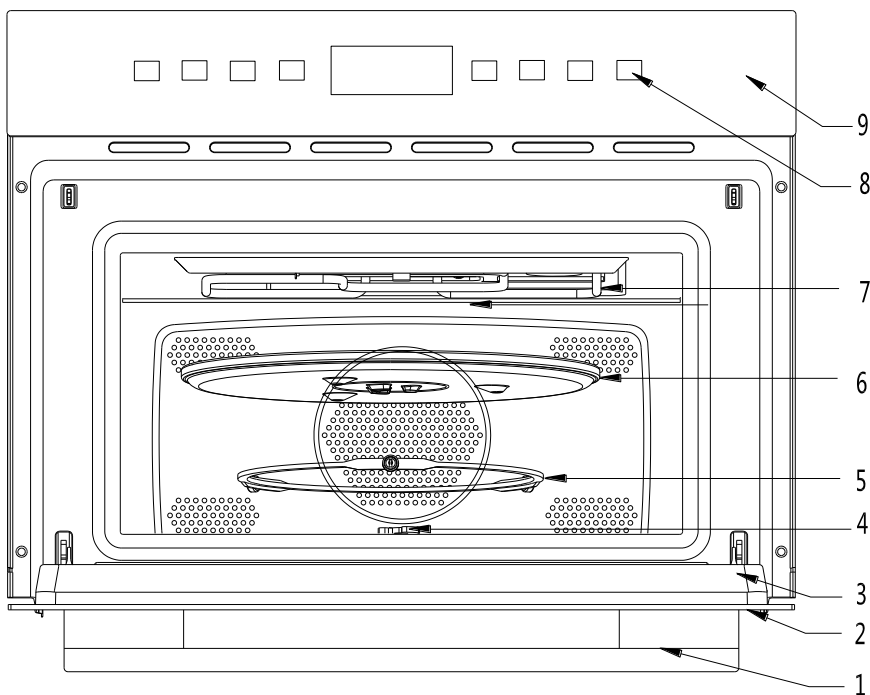

- 1.- Door handle
- 2.- Door window glass
- 3.- Door seal
- 4.- Drive shaft
- 5.- Turntable ring
- 6.- Turntable plate
- 7.- Grill
- 8.-Button
- 9.- Control panel

5. BEFORE INSTALLATION







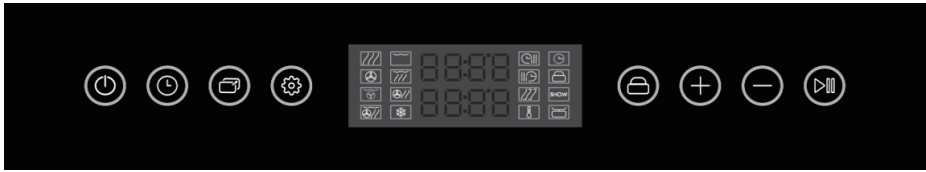

The inside of the appliance should be cleaned to remove all manufacturing residues. For further information about cleaning, see point ‘Cleaning and Maintenance’.

6. DESCRIPTION OF FRONT PANEL CONTROL















All the appliance's control and monitoring device are placed together on the control panel. The table below displays icons of different functions.



Buttons Definition;

-  Standby Function (microwave、 grill、 defrost)
-  Cooking Time Setting(cooking time、 delay start time)
-  Other Setting (Power、 weight、 choice of defrost)
-  Clock Setting
-  Child Lock
-  Increase (function、 power、 weight increase)
-  Decrease (function、 power、 weight decrease)
-  Start/Pause

Icon Definition:

- | | |
|--|--|
|  Microwave |  Grill |
|  Convection |  Microwave+Grill |
|  Microwave+Convection |  Grill+Convection |
|  Microwave+Grill+Convection |  Defrost |
|  Working Time |  Clock |
|  Delay Time |  Child Lock |
|  Microwave Power |  Show |
|  Temperature |  Weight |

INSTRUCTIONS FOR THE USER







7.USING THE OVEN

When the oven is used for the first time, it should be heated to the maximum temperature for long enough to burn off any oily residues left during the manufacturing process, which might contaminate foods with unpleasant smells.

In case too much condensation produced on the inner glass of the microwave door and inside the cavity, don't leave cooked food in the microwave for long.

8. FUNCTIONS

8.1 Time Setting



When power is on, display screen shows a flashing "0:00; time could be set, Press the button " " or " " to increase or decrease to set hour; After hour is set, Press the symbol of clock setting " " again to set the minutes. Press " " or " " to increase or decrease the minutes and press " " to set the current time. Press " " again, time set is finished.

The range of Clock Setting is between 0:00 and 23:59



Change the current time

When the appliance is in standby mode and clock displays on screen, press “” for three seconds, the current time flashes on the screen, and new time could be set.

Clock displays setting



When the appliance is in standby mode, press “”, and clock will displays on screen; press “” again, and clock will not display on screen.



8.2 Selecting The Functions



After pressing “” for 1 second under standby mode, the appliance will be on function select mode. Suggested time and data (including microwave power, weight, etc) will be shown on screen. You can select your wanted function by pressing “” and “”.

8.2.1 Microwave Functions

After selecting this function, the indicator “”, “” and “” light up. Screen shows 01:00 and 800W.

Press “” to set the cooking time. When the preset time is flashing, press “” or “” to adjust the cooking time. The MAX time is 90:00 (The first 30 minutes is 100% power, and the rest 60 minutes is 80%)



Press “” to set the microwave power. When the preset power is flashing, press “” or “” to adjust the microwave power. Microwave power: 1000/800/600/400/200/0W



Press “” to start cooking, and cooking time will count down. The symbol of microwave “” is flashing.
microwave power table

display	1000W	800W	600W	400W	200W	0W
power	high	Mid-high	middle	Mid-low	low	cool



8.2.2 Grill Function



After selecting this function, the indicator “” and “” light up. Screen shows 15:00



Press “” to set the cooking time. When the preset time is flashing, press “” or “” to adjust the cooking time. The MAX time is 90:00



Press “” to start cooking, and cooking time will count down. The symbol of grill “” is flashing.

8.2.3 Convection

After selecting convection function, “”, “” and “” light up and the screen shows 5:00 and 110°C

Press “” to set cooking time. when the preset time 5:00 is flashing on the screen, the cooking time could be adjusted by pressing “” or “”;

Press “” to set temperature. when the preset temperature 110 is flashing on the screen, the temperature could be adjusted by pressing “” or “”;

Press “” to start cooking, the working time will count down while “” and “” are flashing.



The range of the temperature is from 110°C to 230°C.



The longest working time is 90 minutes.



Note: During the working process, the current time could be checked by pressing “”.

8.2.4 Microwaves + Grill Function

After selecting the function, the indicator “”, “” and “” light up. Screen shows 10:00 and 400W;

Press “” to set the cooking time. When the preset time is flashing, press “” or “” to adjust the cooking time. The MAX time is 90:00

Press “” to set the microwave power. When the preset microwave power 400 is flashing on the screen, the power could be adjusted by pressing “” or “”.

Press “” to start cooking, and cooking time will count down, The symbol of microwave + grill “” is flashing.

There are three kinds of power 600W, 400W, 200W for selecting.

The longest working time is 90 minutes.

- The microwave + Grill are ideal for cooking quickly and browning foods after cooking. Furthermore, you can also grill and cook cheese covered food. The microwave and the grill work simultaneously. The microwave cooks and the grill toasts.

Before using a dish in the microwave oven make sure that it is suitable for microwave use. Only use dishes or containers that are suitable for microwave use.

The dish to be used in the combined function should be suitable for microwave and grill use. See the section on types of ovenware!



Keep in mind that the figures given are merely indicative and can vary as a function of the initial state, emperature, moisture and type of food.



If the time is not enough to brown the food well, put it under the grill for another 5 or 10 minutes.



Please allow the standing times and don't forget to turn the meat pieces. Unless indicated to the contrary, use the turntable plate for cooking. The values given in the tables are valid when the oven cavity is cold (it is not necessary to pre-heat the oven).



FOOD	QUANTITY(G)	DISH	POWER (W)	TIME (MIN)	STANDING TIME (MIN)
CHEESE TOPPED PASTA	500	LOW DISH	400	12-17	3-5
CHEESE TOPPED POTATOES	800	LOW DISH	600	20-22	3-5
LASANGE	APPROX.800	LOW DISH	600	15-20	3-5
GRILLED CREAM CHEESE	APPROX.500	LOW DISH	400	18-20	3-5
2 FRESH CHICKEN LEGS (GRILLED)	200 EACH	LOW DISH	400	10-15	3-5
CHICKEN	APPROX.1000	LOW LAND WIDE FISH	400	35-40	3-5
CHEESE TOPPED ONION SOUP	2×200G CUPS	SOUP BOWLS	400	2-4	3-5

8.2.5Grill+Convection

After selecting the function, the indicator, “” “” and “” light up with the screen shows 5:00 and 110°C

Press “” to set the working time. When the preset time is flashing, you can adjust the working time by pressing “” and “”, and the longest working time is 90 minutes.

Press “” to set the temperature. When the preset temperature 110 is flashing on the screen, the temperature could be adjusted by pressing “” or “”.



Press “” to start cooking, and the working time count will down while the symbols “” and “” are flashing. The range of the temperature for selecting is from 110°C to 230°C.

The longest working time is 90 minutes.



Note: During the working process, the current time could be checked by pressing “”.



8.2.6Microwave+Convection



After selecting the function, “” “” and “” light up with the screen shows 10:00 and 400W.

Press “” to set the working time. When the preset time is flashing, you can adjust the working time by pressing “” and “”, and the longest working time is 90 minutes.

Press “” to set the microwave power. When the preset microwave power 400 is flashing on the screen, the



power could be adjusted by pressing “” or “”.



Press “” again to set the temperature. When the preset temperature 110 is flashing on the screen, the temperature could be adjusted by pressing “” or “”.



Press “” to start cooking, the working time will count down while the symbol “” is flashing.



8.2.7 Microwave+Grill+Convection

After selecting the function, the indicator “” “” and “” light up with the screen shows 10:00 and 400W.

Press “” to set the working time. When the preset time is flashing, you can adjust the working time by pressing “” and “”, and the longest working time is 90 minutes.

Press “” to set the microwave power. When the preset microwave power 400 is flashing on the screen, the power could be adjusted by pressing “” or “”.



Press “” again to set the temperature. When the preset temperature 110 is flashing on the screen, the temperature could be adjusted by pressing “” or “”.



Press “” to start cooking, the working time will count down while the symbol “” is flashing.



There are three kinds of power 600W, 400W, 200W for selecting.



The longest working time is 90 minutes.



8.2.8 Defrost

After selecting the function, the indicator “” and “” light up. Screen shows PR01 and 100.

Press “” to switch to Defrost by Weight program. Then press “” or “” to select the corresponding program. There will be 5 programs from PR01 to PR05 for choosing;

Press “” again to set the weight, then press “” or “” to adjust the weight. The range of weight is from 100-2500. (Different programs have different weight)









Press “” to start cooking, and cooking time will count down. The symbol of defrost by weight “” is flashing.

In the defrosting process, the appliance will stop when the time reached the half set time. And there will be three beeps every 30 seconds for reminding. And the symbol “” will stop flashing while the word “turn” appears on the screen and flash. You should open the door and turn the food over. Then close the door and press “” to continue defrosting.

We can calculate the defrosting time according to different food and weight, and microwave power can adjust automatically to reach the best defrosting effect. Furthermore, the table beneath offers reference value of defrosting referring to the weight, which includes weight level, defrosting time and follow-up time.

PROGRAM	FOOD	WEIGHT (Gram)	TIME (Min)	DURATION TIME (Min)
PR 01	Meat	100-2000	2:20-43:30	20-30
PR 02	Bird species	100-2500	2:10-58:10	20-30
PR 03	Fish	100-2000	2:00-40:00	20-30
PR 04	Fruit	100-500	2:36-13:00	10-20
PR 05	Bread	100-800	2:25-19:20	10-20

8.3 Delayed Start Time (Automatic cooking)

After cooking time and function is set, press “” again to set delay start time. “” lights up, screen displays current time (hour is flashing), Press “” or “” to set delay start time (hour), press “” again, time (minutes) will flash. Press “” or “” to set delay start time (minutes). Press “” to confirm the delay start time setting, If press “” again, the appliance will work directly.

Screen shows the delayed start time and current time in turn when the appliance is under standby mode.

Press “” for 1 second if you want to cancel the selected function.

8.4 Pause In The Process Of Cooking

8.4.1 You can stop the cooking process at any time by pressing “” or by opening the oven door. At the same time when the appliance suddenly stops working, but Screen still displays the rest of the operating time still.

If you wish, at this time you can:

Turn or stir the food to ensure it will be evenly cooked;

Modify the process parameters;

Cancel the process by pressing “” for 1 second;

To start the process, close the door and press “”.

8.4.2 Modifying parameters

The operating parameters (time, weight, power, etc.) can only be modified when the cooking process has been interrupted. Proceed as follows:



After pressing “” one second under standby mode the appliance will switch to function menu.

Press “” and “” or “” to set cooking time;

Press “” to switch to Power Setting Model;

Press “” to continue cooking process.







8.5 End cooking and cancel program



At the end of the process you will hear three beeps and the display will show the word ‘End’, The symbol “” light. The beeps repeat every 30 seconds in five minutes until the door is opened or “” is pressed. The oven returns to the OFF setting

During the process of setting program or oven working, press “” for 1 second and the appliance stops working to go into standby mode

8.6 Show Room and Child Lock



8.6.1 Show Room (the appliance seems working but heating elements with no power)

Under standby mode, press “” and “” at the same time until the words “OFF SHO” appear on the screen. Now press “” or “” once, the appliance goes in showing mode. Press “” or “” again, showing mode will be closed. After setting, press “” to go back to standby mode. Notice: The showing function is convenient for sales, for normal using, it should be set to off showing mode. So this function is not required to be set.

Under showing mode, whatever function is chosen, the symbol “” lights after pressing “”.

8.6.2 Child Lock

On Lock: Under standby mode or working process, press “” for 3 seconds, the appliance will be locked with a sound “di”.

Unlock: Press “” for 3 seconds, the appliance will be unlocked after a sound “di”. The symbol “” disappears.

8.7 Cooling Fan System

The appliance is equipped with a cooling system which comes into operation as soon as a cooking function starts.

Operation of the fans generates a normal air flow which comes out above the door and may continue for a short time even after the appliance is switched off.

8.8 Door Interlock Switch

The light is on when the door interlock switch is not connected or closed incompletely, and it is available to set the parameter, but you can't start the microwave.

The screen displays “door” when you press Start/Pause button, in the condition that the door interlock switch is not connected or not closed. It would return to setting interface after 3 seconds.

8.9 Inside Light

The appliance light comes on:

- 1)、working condition except pause;
- 2)、When the oven door is opened in standby status;
- 3)、If the oven door is left open, the oven light will automatically shut-off after 10 minutes.

9. RECOMMENDED BAKING MENU

9.1 Cooking With Microwave

Warning! Read the section 'Safety Precautions' before cooking with your microwave.

Follow these recommendations when cooking with microwave:

- Before heating or cooking foods with peel or skin (e.g. apples, tomatoes, potatoes, sausages) peel them so that they do not burst. Cut the food up before starting to prepare it.
- Before using a container or dish make sure that it is suitable for microwave use (see the section on types of ovenware)
- When cooking food with very little moisture (e.g. defrosting bread, making popcorn, etc.) evaporation is very quick. The oven then works as if it was empty and the food may burn. The appliance and the container may be damaged in such situation. You should therefore set just the cooking time necessary and you should keep a close eye on the cooking process.
- It is not possible to heat with much oil (frying) in the microwave.
- If you have several containers, such as cups, for example, set them out uniformly on the turntable plate
- Do not seal plastic bags with metal clips. Use plastic clips instead. Prick the bags for several holes so that the steam can escape.
- Check that they reach at least a temperature of 70°C When heating or cooking foods.
- There might come steam on the oven door window during cooking and may start to drip. This situation is normal and may be more noticeable if the room temperature is low. The process of cooking is not affected by this. After you have finished cooking, clean up the water coming from the condensation.
- When heating liquids, use containers with a wide opening, so that the steam can evaporate easily.

Prepare the foods as per the instructions and keep in mind the cooking times and power levels indicated in the tables.

Keep in mind that the figures given are only indicative and can vary depending on the initial state, temperature, moisture and type of food. It is depending on the initial state, temperature, moisture and different types of food. It is advisable to adjust the times and power levels to each situation. Depending on the exact characteristics of the food you may need to increase or shorten the cooking times or increase or decrease the power levels.

Cooking with microwave

1. The greater the amount of food, the longer the cooking time. Keep in mind that:
 - △ Double the quantity = double the time
 - △ Half the quantity = half the time
2. The lower the temperature, the longer the cooking time.
3. Foods containing a lot of liquid heat up more quickly
4. Cooking will be more uniform if the food is evenly distributed on the turntable. If you put dense foods on the outer part of the plate and less dense ones on the centre of the plate, you can heat up different types of food simultaneously.
5. You can open the oven door at any time. When you do this the oven switches off automatically. The microwave will only start working again when you close the door and press the start key.
6. It takes less time if we put a cover over food, but the cover should have vents avoiding extreme pressure.

9.1.1 Vegetables

Name	Weight (gram)	Water (ml)	Fire power	Time (Min)	Follow-up time (Min)	Notice
Cauliflower	500	100	800	9-11	2-3	Cut into slices Cover well
Broccoli	300	50	800	6-8	2-3	
Mushroom	250	25	800	6-8	2-3	
Peas, carrots, frozen carrots	300 250	100 25	800 800	7-9 8-10	2-3 2-3	Cut into slices or blocks, cover well
Potatoes	250	25	800	5-7	2-3	Peel and cut into uniform size, cover well
Chives	250	25	800	5-7	2-3	Cut into segments or slices, cover well
Frozen cabbage	300	50	800	6-8	2-3	Cover well

9.2. Defrosting with Microwaves

General instructions for defrosting

1. When defrosting, use only dishes that are appropriate for microwaves.
2. The defrost function by weight and the tables refer to the defrosting of raw food.
3. The defrosting time depends on the quantity and thickness of the food. When freezing food keep the defrosting process in mind. Distribute the food evenly in the container.
4. Distribute the food well. You can use aluminum foil delicate food. Important: The aluminum foil should not come into contact with the oven inner cavity of the oven as this may cause electrical arcing.
5. Thick portions of food should be turned over several times in the process of baking.
6. Distribute the frozen food as evenly as possible since narrow and thick portions defrost more quickly than the thicker and broader parts.
7. Fat-rich foods such as butter, cheese and cream should not be completely defrosted. If they are kept at room temperature they will be ready to be served in a few minutes. With ultra-frozen cream, if you find small pieces of ice in it, you should mix these in before serving.
8. Place poultry on an upturned plate so that the meat juices can run off more easily.
9. Bread should be wrapped in a napkin so that it does not become too dry.
10. Remove frozen food from its wrapping and do not forget to take off any metal twist-tags. For containers that are used to keep frozen food in the freezer and which can also be used for heating and cooking, all you need to do is take off the lid. For all other cases you should put the food into containers that are suitable for microwave use.
11. The liquid resulting from defrosting, principally that from poultry, should be discarded. In no event should such liquids be allowed to come into contact with other foods.
12. Do not forget that by using the defrosting function you need to allow for standing time until the food is completely defrosted.
13. In defrost process, please turn food over when microwave oven alarms and displays "turn".

Please refer to the following table for different temperature of various food.

Name of food	Weight (gram)	Defrosting time (Min)	Follow-up time (Min)	Frequency of turnover
Meat(veal, beef, pork)	100	2-3	5-10	1
	200	4-5	5-10	1
	500	10-12	10-15	2
	1000	21-23	20-30	2
	1500	32-34	20-30	2
	2000	43-45	25-35	3
Beef stew	500	8-10	10-15	2
	1000	17-19	20-30	3
Minced meat	100	2-4	10-15	2
	500	10-14	20-30	3
Sausage	200	4-6	10-15	2
	500	9-12	15-20	3
Poultry	250	5-6	5-10	1
Chicken	1000	20-24	20-30	2
Dorking	2500	38-42	25-35	3
Fish fillet	200	4-5	5-10	1
Trout	250	5-6	5-10	1
Prawn	100	2-3	5-10	1
	500	8-11	15-20	2
Fruit	200	4-5	5-10	1
	300	8-9	5-10	1
	500	11-14	10-20	2
Bread	200	4-5	5-10	1
	500	10-12	10-15	1
	800	15-17	10-20	2
Butter	250	8-10	10-15	
Cheese	250	6-8	10-15	
Cream	250	7-8	10-15	

9.3. Cooking with the Grill

For a better baking, use the rack supplied.

Insert the rack in the way that it doesn't come into contact with the metal surface of the oven cavity in case any danger of electric arcing which may damage the oven.

IMPORTANT POINTS:

1. There will be some smoke and smell when the grill is used for the first time. That is because of oil left from the manufacture process.
2. The glass of oven door becomes very hot when the oven is working. Keep children away.
3. When the grill is used for extended period of time, it is normal to find that the elements will switch themselves off temporarily due to the safety thermostat.
4. Important: When food is to be grilled or cooked in containers you should check that the container is suitable for microwave use. See the section on types of ovenware!
5. When the grill is used it is possible that some splashes of fat may go onto the elements and be burnt. This is a normal situation and does not mean there is any kind of operation fault.

6. After you have finished cooking, clean the interior and the accessories so that cooking remains do not become encrusted.

GRILL ELEMENT

Name	QUANTITY(G)	TIME(MIN.)	INSTRUCTIONS
FISH			
BASS	800	18-24	SPREAD LIGHTLY WITH BUTTER. AFTER HALF OF COOKING TIME TURN AND SPREAD WITH SEASONNING.
SARDINES/GURNARD	6-8 FISH	15-20	
MEAT			
SAUSAGES	6-8 UNITS	22-26	PRICK AFTER HALF COOKING TIME AND TURN
FROZEN HAMBURGERS	3 UNITS	18-20	
SPARE RIB (APPROX.3 CM THICK)	400	25-30	AFTER HALF OF COOKING TIME, BASTE AND TURN
TOAST	4 UNITS	3/2-3	WATCH TOASTING
TOASTED SANDWICHES	2 UNITS	5-10	WATCH TOASTING

9.4 Pizza function

It is not necessary to pre-heat the browning plate to cook pizzas.

Place the pizza directly on the browning plate.

Place the browning plate on the centre of the glass turntable in the microwave oven.

Warning: the cavity wall and the browning plate become very hot. Care should be taken to avoid touching heating elements, cavity wall or the browning plate. The usage of oven gloves is strongly recommended to avoid burns.

9.5 What kind of ovenware can be used?

9.5.1 Microwave function

For the microwave function, notice that glass, china, clay, plastic, and paper can be used as container. Metal pans, dishes or containers with metal parts or decorations cannot be used in the microwave. Glassware and clay with metallic decoration or content (e.g. lead crystal) cannot be used for microwave oven.

The ideal material for microwave oven is glass, refractory china or clay, or heat resistant plastic. Very thin, fragile glass or china should only be used for short period of time (e.g. heating)

Always wear oven gloves to take mature food.

To test ovenware, put the item in the oven for 20 seconds at maximum microwave power, after 20 seconds, take the ovenware out immediately, it is suitable to use if it is cold or just slightly warm. However, it is not suitable for microwave oven if it heats up a lot or causes electric arcing.

9.5.2 Grilling

In the case of the grill function, the ovenware should be resistant to temperature of at least 300°C. Plastic dishes are not suitable for the grill function.

9.5.3 Combination functions

In the combination functions (microwave + conventional heating elements), the ovenware used should be suitable for microwave and grill.

9.5.4 Aluminum containers and foil

Pre-cooked food in aluminum containers or in aluminum foil can be put in the microwave if the following aspects are respected.

- Be noticed that manufacturer's recommendations written on the external packing.
- The aluminum containers cannot be more than 3 cm high or come in contact with the cavity walls (minimum distance 3 cm). Any aluminum lid or top should be removed.
- The cooking time is longer because the microwaves only permeate into food from the top. If you have any doubts, it is best to use only dishes suitable for microwave use.
- Important: aluminum foil cannot come into contact with the cavity walls since this may cause electrical arcing.

● Lids

We recommend you use glass or plastic lids or cling film:

1. In case of excessive evaporation (mainly during very long cooking times)
2. Cooking time is shorter
3. The aroma is preserved

The lid should have holes or openings so that no pressure produces. Plastic bags should be opened.

Baby feeding bottles or jars with baby food and similar containers can only be heated without tops/lids on otherwise they may burst.

10. CLEANING AND MAINTENANCE

Before carrying out any operations, disconnect the appliance from the electricity supply. Take the plug out of the socket or switch of the oven's power circuit.

Warning! Never use a jet of steam for cleaning the inside of the oven.

Warning! The microwave oven should be cleaned regularly, with all food remains being removed. The surface of microwave may deteriorate if it is not clean. That may reduce the oven's working life and possibly result in a dangerous situation.

10.1. Cleaning Stainless Steel

To keep stainless steel in a good condition, it should be cleaned regularly.

10.2 Daily Cleaning Routine

When cleaning and caring for stainless steel surfaces, always use only specific products which do not contain abrasives or chlorine-based acids.

Instructions for use: Pour the product onto a damp cloth and wipe over the surface, then rinse thoroughly and dry with a soft cloth or chamois leather.

10.3 Food Stains Or Spills

Never use metal scouring pads or sharp scrapers which may damage the surface of the oven.

Use ordinary non-abrasive products with the aid of wooden or plastic utensils if necessary. Rinse thoroughly and dry with a soft cloth or chamois leather.

10.4 Cleaning The Oven Cavity

Cleaning is the only maintenance normally required. Every time after cooking, clean the inner cavity with a damp cloth since this is an easier way to remove splashes or spots that may stick to the cavity.

To remove dirt that is harder to shift, use a non-aggressive cleaning product. Do not use oven sprays or other aggressive or abrasive cleaning products.

Always keep the door and the oven front very clean to ensure that the door opens and closes properly.

Make sure water does not permeate into the microwave ventilation holes.

Regularly take out the turntable plate and the respective support and clean the cavity base, especially after any liquid spillage.

Microwave should not work without turntable.

If the oven cavity is very dirty, put a glass of water on the turntable and switch on the microwave oven for 2 or 3 minutes at maximum power. The steam released will soften the dirt which can then be cleaned easily using a soft cloth. Unpleasant odors (e.g. after cooking fish) can be eliminated easily. Put a few drops of lemon juice in a cup with water. Put a spoonful of coffee in the cup to avoid the water boiling over. Heat the water for 2 to 3 minutes at maximum microwave power.

10.5 Cleaning The Cavity Ceiling

If the oven ceiling is dirty, to avoid the danger of burning, wait until the grill is cold before lowering it.

Do not use abrasive cleaning products or sharp objects.

To avoid any risk, do not remove the mica cover.

The glass lamp cover is located on the oven ceiling and can be removed easily for cleaning. For this you just need to unscrew it and clean it with water and dishwashing liquid.

10.6 Rinse Of Door Seal And Front Panel

Please rinse in time if there are residues left in door seal or on front panel. Do not use rough cleaning tools like hard brush, coarse cloth, wire netting, knife or any other sharp tools, using those sharp tools may scratch door seal or the surface of the front panel. Please use non-abrasive detergent. You can use wooden or plastic cleaning tools if it is necessary.

10.7 Cleaning The Accessories

Clean the accessories after each use. If they are very dirty, soak them first of all and then use a brush and sponge. The accessories can be washed in a dish washing machine.

Make sure that the turntable plate and the respective support are always clean. Do not switch on the oven unless the turntable and the respective support are in place.

11. SPECIAL MAINTENANCE

11.1 Replacing The Light Bulb

Concrete operations:

- Take off the plug from power supply.
- Take off the lampshade (1);
- Take down halogen lamp (2); Warning: Hot lamp!
- Fill new halogen lamp (220-240V-25W).
- Operate according to the instruction.
- Install lampshade well.
- Connect the power.

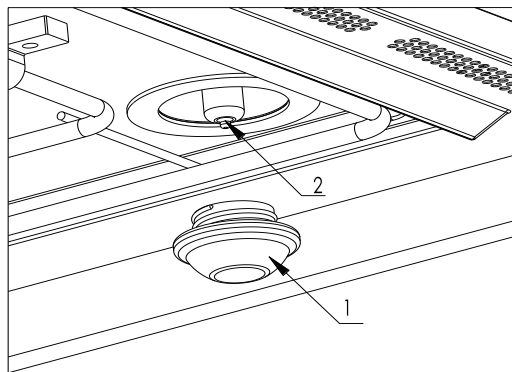

WARNING: The lamp is not suggested for consumer to replace. The replacing should be done by a professional mechanic.

12. INSTALLING THE APPLIANCE

12.1 Before The Installation

Open the oven door and take out all the accessories and remove the packing material.

Make sure that the oven is not damaged by any way. Check that the oven door closes correctly and the inside of the door and front oven panel are not damaged.

12.2 Do Not Use The Oven

If the power cable or the plug is damaged, if the oven does not function correctly or if it has been damaged or dropped. Put the oven on a flat and stable surface. The oven should not be installed close to any heat source, radios or televisions.

During installation, make sure that the power cable does not come into contact with any moisture or objects with sharp edges and the back of the oven. High temperature can damage the cable. Warning: after the oven is installed you should make sure you can access the plug.

12.3 Positioning The Oven

If we put the oven into cabinet, the material cabinet should be insulated, and the clearance between the edge of the cabinet and the oven should be over 100 mm for ventilation.

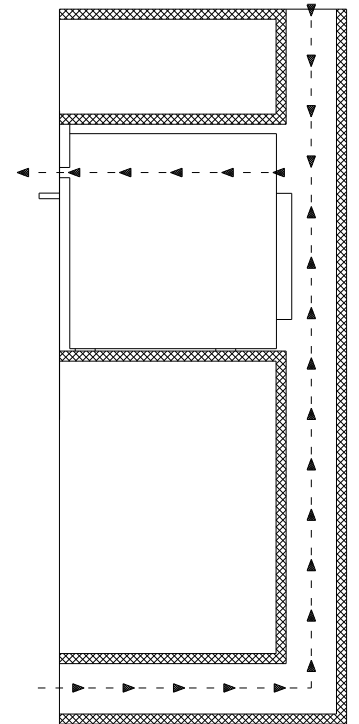
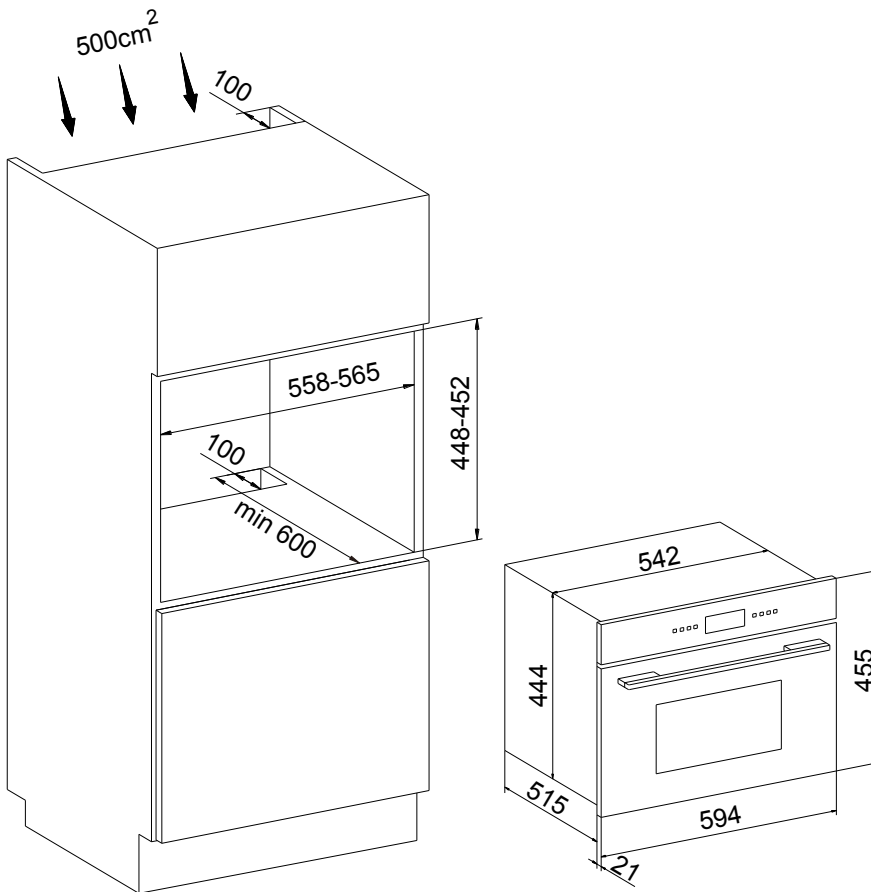
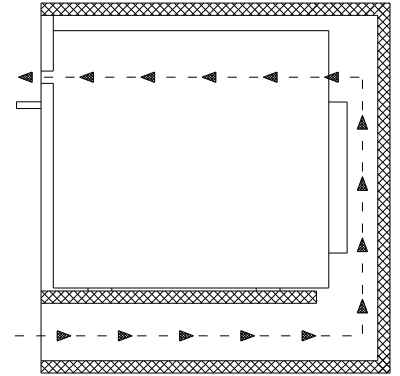
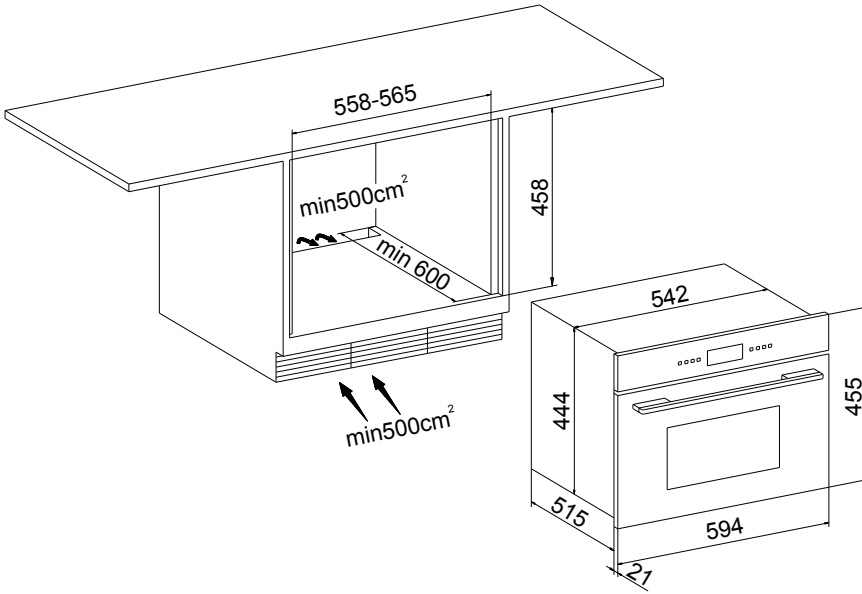

There are 4 screws on the inner side of the oven door frame.

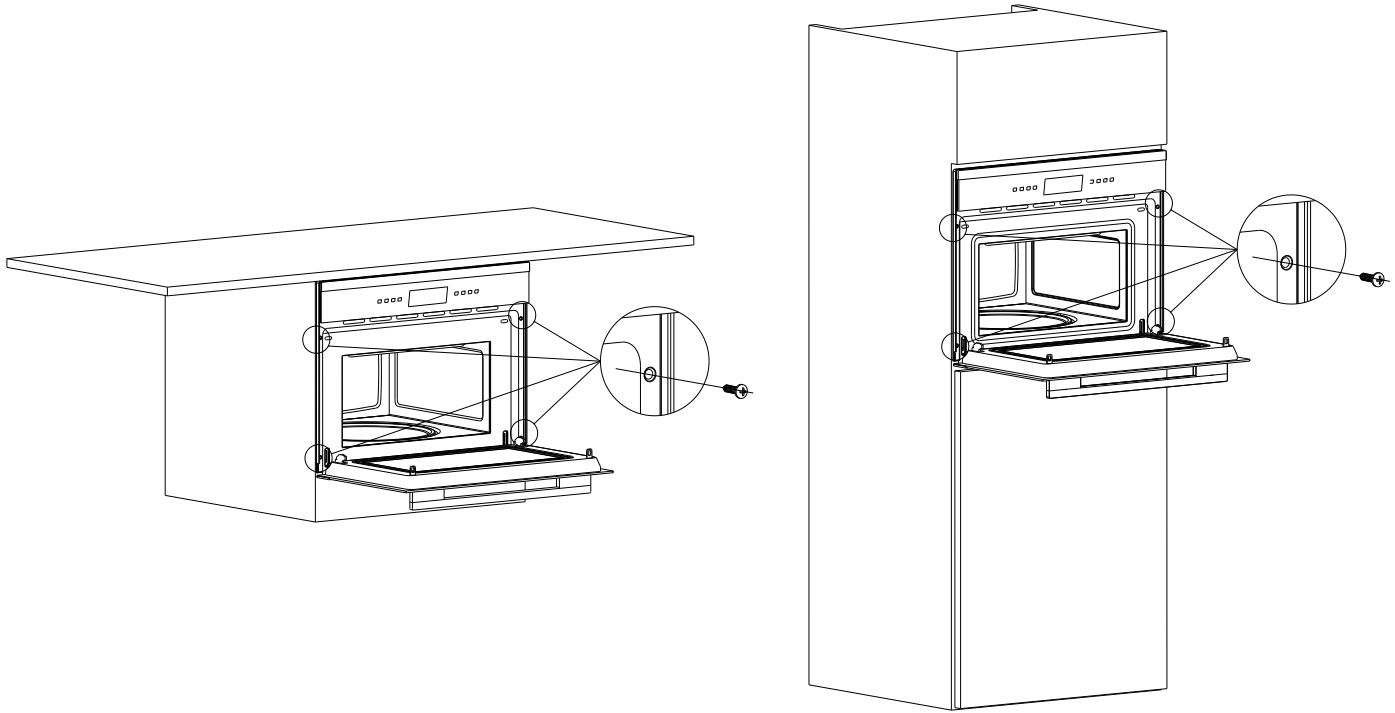

Note: Do not take the door handle as force bearing point during the installation and removal.

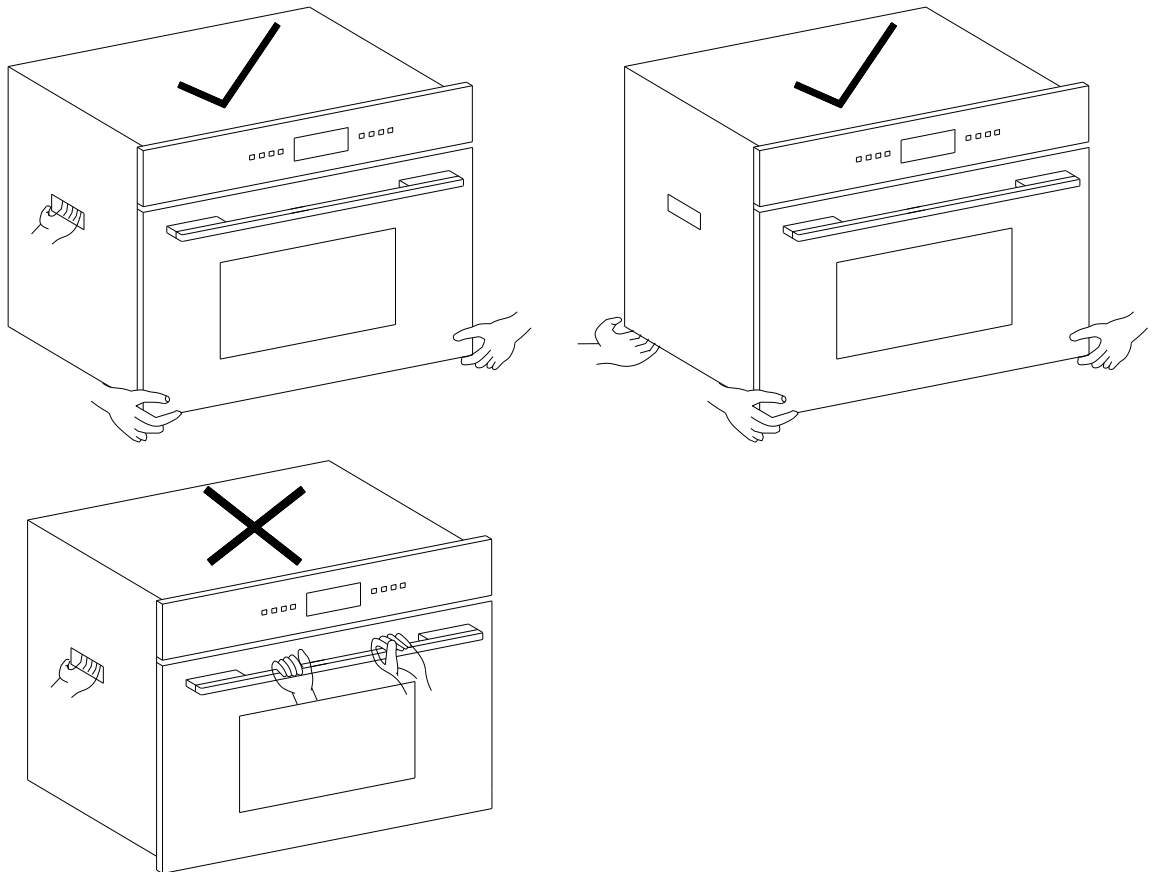

13. TROUBLE SHOOTING

Warning: Maintenance should be done by a professional mechanic.

Circumstances that doesn't need a professional mechanic

With no display!

- Check the time indicator on or off

With no response after press any button!

- Check if safety lock is on or not.

Oven doesn't work!

- Check the plug plugged well
- Check the oven power connected or not.
- Make sure the oven door closed tightly and rightly.
- Ensure nothing caught between the door and front panel of the cavity.

Strange noise happens when oven is in operation!

- Check if metal objects inside the oven arced or not.
- Check if vessel touches inner wall of oven by accident.
- Check if baking equipment becomes loose or not.

The oven can't heat or heat very slowly!

- Usage of metal vessel by accident.
- Check if running time and fire gear setting is appropriate.
- Food put in the oven is too big.

There is still noise after the Microwave Oven stops working!

- This is normal, it takes some time for cooling fan to cool down.

Lamp doesn't work after connecting power!

- It doesn't influence the usage of Microwave Oven if other functions work well.



Franke Kitchen Systems

Services E-mail: KS-AsiaExport.cn@franke.com

www.franke.com