

BELL

BCX611RHD

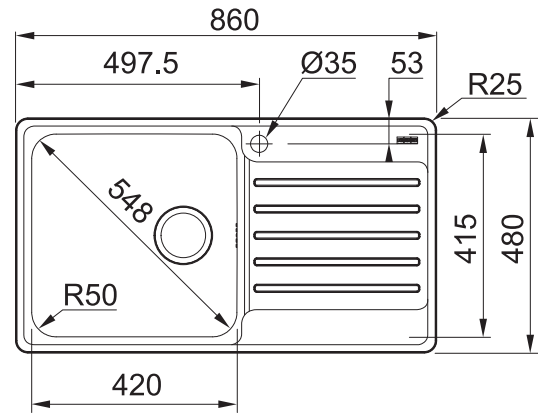

PRODUCT INFORMATION

Installation	Topmount
Dimensions	840 x 480mm
Cabinet Base	600mm
Bowl Size	420 x 415 x 200mm/34L
Bowl Radius	50mm
Cut-Out Size	837 x 457mm, cr=15
Cut-Out Template	No
Waste Outlet	Semi Integrated Waste
Overflow	Yes
Tap Holes	ø35mm
Remote Waste	No
Finish	Stainless Steel
Warranty	50 Years

NOTE: Cut-out dimensions are a guide only, please use the actual sink as your template.

FEATURES & BENEFITS



Food Preparation Centre



18/10 Stainless Steel



Sound Deadening Pads











Fast Fix Installation



Hidden Overflow

ALL-IN ACCESSORIES (AVAILABLE)

PACK 1					
	Telescopic Bridge	Chopping Board	Small Strainer Bowl	Small Storage Box	Bamboo Lid
PACK 2	All Accessories Included In Pack 1				
			Silicon Drainer Mat		
PACK 3	All Accessories Included In Pack 2				
			Large Strainer Bowl	Storage Container	

ADDITIONAL ACCESSORIES ——— Included Accessory
 - - - - - Available Accessory



DB448
Drainer Basket

BARE SINK OPTION AND SOME SINK & TAP PACKAGES DO NOT INCLUDE ACCESSORIES. PLEASE CHAT TO YOUR SALES CONSULTANT FOR FURTHER INFORMATION.

LAST UPDATED: 03 AUGUST 2023

