

TECHNICAL DATASHEET

CENTINOX CEX 210-50/HW

Product Category	Sinks
Finish	Stainless Steel
Installation	Inset/Flushmount
Range	CENTINOX
Model	CEX 210-50/HW
Warranty	50 Years







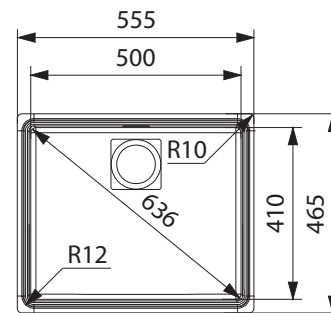

PRODUCT INFORMATION

Article Number	127.0189.153
Dimensions	555 x 465mm
Cabinet Base	600mm
Bowl Size	500 x 410 x 200mm/37L
Bowl Radius	12mm
Cut-Out Size	Inset: 536 x 446mm, cr=30 Flushmount: utilise DXF file
Cut-Out Template	Yes
Waste Outlet	Hygienic Integrated Waste
Overflow	Yes
Tap Holes	No
Remote Waste	Yes
Opposite Configuration	-
Accessories	1 2 3 4 5 6

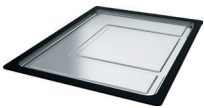

1 ACCESSORIES AVAILABLE **1** ACCESSORIES INCLUDED

ACCESSORIES

- 1**

RM 43
 Rollamat
- 2**

SB 452
 Strainer Bowl
- 3**

TR 453
 Tray
- 4**

CB 062
 Chopping Board
- 5**

DT 587
 Extension Drainer
- 6**

DB 664
 Drainer Basket

FEATURES & BENEFITS

- 
FPC
 Food Preparation Centre
- 
18/10
 Stainless Steel
- 
 Remote-Operated Waste
- 
 Waste to Rear of Main Bowl
- 
 Franke Hidden Overflow
- 
 Sound Deadening Pads
- 
 Hygienic Integrated Waste
- 
 Flushmount Fit

LAST UPDATED: 14 JAN 2016

Make it wonderful

