

IMG 620 ONYX IMPACT

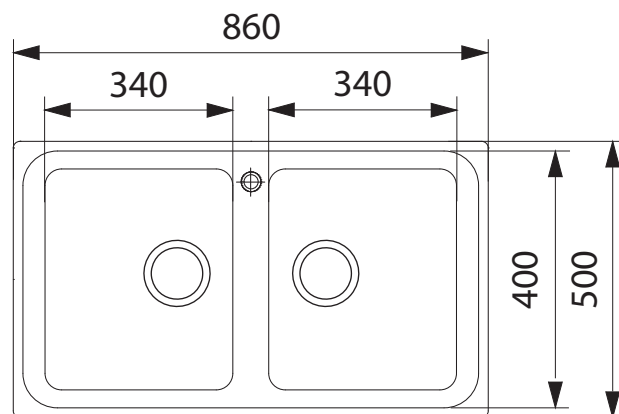





PRODUCT INFORMATION

Installation	Topmount
Dimensions	860 x 500mm
Cabinet Base	800mm
Bowl Size	340 x 400 x 200mm/27L (x2)
Bowl Radius	30mm
Cut-Out Size	840 x 480mm, cr=20
Cut-Out Template	No
Waste Outlet	Semi Integrated Waste
Overflow	Yes
Tap Holes	Part Drilled
Remote Waste	No
Finish	Fragranite

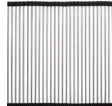

1 ACCESSORIES AVAILABLE **1** ACCESSORIES INCLUDED

ACCESSORIES

- 1**

DB 840
 Drainer Basket
- 2**

CB 761
 Chopping Board
- 3**

CB 931
 Chopping Board
- 4**

RM 44
 Rollamat
- 5**

DT 651
 Extension Drainer
- 6**

CB 523
 Chopping Board

LAST UPDATED: 1 MARCH 2021