

# ACTIVE

TA7790MB



## PRODUCT INFORMATION

<b>Style</b>	Non Pull-Out
<b>Tap Swivel Spout (degrees)</b>	180°
<b>Cut-Out Size</b>	Ø 35mm
<b>WELS</b>	6 star / 4.5 Lpm Reg No: T40656
<b>Min. (PSI)</b>	14.5
<b>Max. (PSI)</b>	70
<b>Min. (kPa)</b>	100kPa
<b>Max. (kPa)</b>	500kPa
<b>Finish</b>	Matte Black
<b>Warranty</b>	5 years parts and labour 15 years cartridge only *T&C's apply

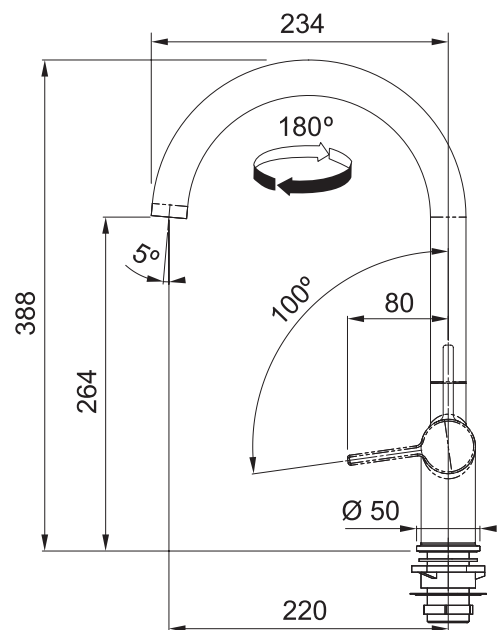

**PLEASE NOTE:** Large and heavy taps should ideally be mounted directly through the solid benchtop or fully supported from underneath. For all other swivel taps, we recommend the use of the Franke Tap Support Arm to provide additional support. Please ensure all Franke tapware is installed at a pressure of no greater than 500 kPa in accordance with AS/NZS3500 and insist that your plumber flushes all of the water supply lines before installing tapware. Failure to do so may void warranty.